

Ulysses mini

Compact dual payload marine thermal camera

Contents

01 - Important information.....	3
1.1 For your safety.....	3
1.2 Notices.....	4
02 - Introduction.....	5
2.1 Document information.....	5
2.2 What's in the package.....	5
2.3 Optional accessories.....	6
2.4 Installation tools requirements.....	6
2.5 Getting to know the camera.....	7
03 - Installation & setup.....	8
3.1 Installation checklist.....	8
3.2 Cable management.....	8
3.3 Layout & location.....	9
3.4 Mounting the Camera Turret.....	11
3.5 Installing the Junction Box.....	12
3.6 The Joystick Controller.....	14
3.7 Connecting to your display options.....	15
3.7.1 Connecting to your MFD.....	15
3.7.2 Connecting to a laptop/desktop.....	16
3.7.3 Connecting to an analog monitor.....	17
3.8 Change IP Settings.....	18
04 - Operations.....	19
4.1 Powering-up.....	19
4.2 Login to camera.....	20
4.3 Gyro calibration.....	21
4.4 Thermal display image.....	22
4.5 Operating the camera.....	23
4.6 Camera control.....	25
05 - Menu.....	26
5.1 Color Palette.....	27
5.2 Zoom.....	28
5.3 Brightness & Contrast.....	29
5.3.1 NUC.....	29
5.4 Radar Track.....	30
5.4.1 Stabilization.....	30
5.4.2 Heading Lock.....	30
5.4.3 Radar Slave (Slew-to-Cue).....	31
5.4.4 Radar Target Track.....	31

5.5 Settings.....	32
5.5.1 Information	32
5.5.2 Device Access.....	33
5.5.3 Network Setup	35
5.5.4 Video	36
5.5.5 Position	37
5.5.7 Controller.....	41
5.5.8 Junction Box	43
5.5.9 NMEA.....	44
5.6 Home/Standby.....	45
06 - Day Camera.....	46
6.1 Menu	47
6.2 Zoom	48
6.3 Brightness & Contrast.....	49
6.4 Radar Track / Stabilization	49
6.5 Settings.....	50
6.5.1 Video Advanced Settings	50
07 - Joystick Controller.....	55
08 - Maintenance.....	57
8.1 Caring for the camera.....	57
8.2 Storage	57
8.3 Service and maintenance.....	57
09 - Troubleshooting.....	58
10 - Specifications.....	60

01 - Important information

1.1 For your safety

To prevent damage to your Omnisense Systems product or injury to yourself or others, read the following safety precautions in their entirety before using this equipment. Keep these safety instructions where all those who use the product will read them.



WARNING

The consequences that could result from failure to observe the precautions listed in this section.

Product installation and operation

This product must be installed and operated by the instructions provided. Failure to do so could result in injuries, damage to the vessel and/or poor product performance.

Corrosion

To avoid excessive galvanic corrosion of the product, use non-metallic insulation when fitting the product directly onto stainless steel platforms/mounts or vessels.

Power supply voltage

Connecting this product to a voltage supply greater than the specified maximum rating may cause permanent damage to the unit. Refer to the technical specification for voltage rating.

Power supply protection

When installing this product, ensure the power source is adequately protected using a suitably rated fuse or automatic circuit breaker.

Potential ignition source

Do not use electronic equipment in the presence of flammable gas, as this could result in an explosion or fire. Also, do not install in a hazardous/ flammable atmosphere such as engine room or near fuel tanks.

Entrapment hazard

This product features moving parts that may pose potential hazards for entrapment. Therefore, always keep clear of moving parts.

Ensure safe navigation

This product is intended only as an aid for navigational safety and must not be used as a substitute for sound navigational skills and practice. Always maintain a permanent watch while the vessel is underway. Failure to maintain a permanent watch puts yourself, your vessel, and others at serious risk of harm.

IMO and SOLAS

This product is intended for marine vessels not covered by the International Maritime Organization (IMO) and Safety of Life at Sea (SOLAS) Carriage Regulations.

Using the supplied cables as is

Do not cut or extend all Omnisense Systems supplied cables unless doing so is detailed in the installation manual.

Do not open or disassemble

The unit is factory sealed to protect against atmospheric humidity, suspended particulates, and other contaminants. Do not open the camera turret for any reason. Disassembly of the camera turret or any unauthorized tampering can cause permanent damage to the system and will void the manufacturer's warranty.

Warranty registration

To register your Omnisense Systems product ownership, please visit our website at www.omnisense-system.com and register online. You must register your product to receive full warranty benefits. Your unit package includes a bar code label indicating the unit's serial number. You should retain the label for future reference.

1.2 Notices

© Omnisense Systems, 2021. All rights reserved. No part of the manuals included with this product may be reproduced, transmitted, transcribed, stored in a retrieval system, or translated into any language in any form, by any means, without Omnisense Systems' prior written permission. Names and marks appearing on the products herein are registered trademarks or trademarks of Omnisense Systems and/or its subsidiaries. All other trademarks, trade names, or company names referenced herein are used for identification only and are the property of their respective owners.

Due to our policy of continuous product improvement, Omnisense Systems reserves the right to change the hardware and software specifications described in these manuals at any time and without prior notice.

Omnisense Systems will not be held liable for any damages resulting from the use of this product.

While every effort has been made to ensure that the information in these manuals is accurate and complete, we would appreciate it if you were to bring any errors or omissions to the attention of the Omnisense Systems representative in your area.



In accordance with European Union (EU) Waste Electrical and Electronic Equipment Directive 2002/96/EC (WEEE), all Electrical and Electronic Equipment (EEE) products labeled with the "crossed-out wheeled bin" either on the product itself or in the product literature is to be collected separately. Therefore, the following applies only to users in European countries:

This product is designated for a separate collection at an appropriate collection point. Therefore, do not dispose of as household waste.

Separate collection and recycling helps conserve natural resources and prevent negative consequences for human health and the environment that might result from incorrect disposal.

Contact the retailer or the local authorities in charge of waste management for more information.

02 - Introduction

Thank you for choosing the Ulysses Mini. The Ulysses Mini system comes with all the components ready to install (in most cases) and operate, making it the most user-friendly marine thermal camera system available. It is designed to integrate with many popular Multi-function Displays (MFDs) seamlessly. Please check our website support page for the latest supported brands and models. This manual will provide you with all the information you need for installation and familiarize you with the functions.

2.1 Document information

This document contains relevant information about the installation and operation of the camera system you have purchased. It is also available for download from our website: www.omnisense-systems.com.

2.2 What's in the package

Ulysses Mini system includes the following items:

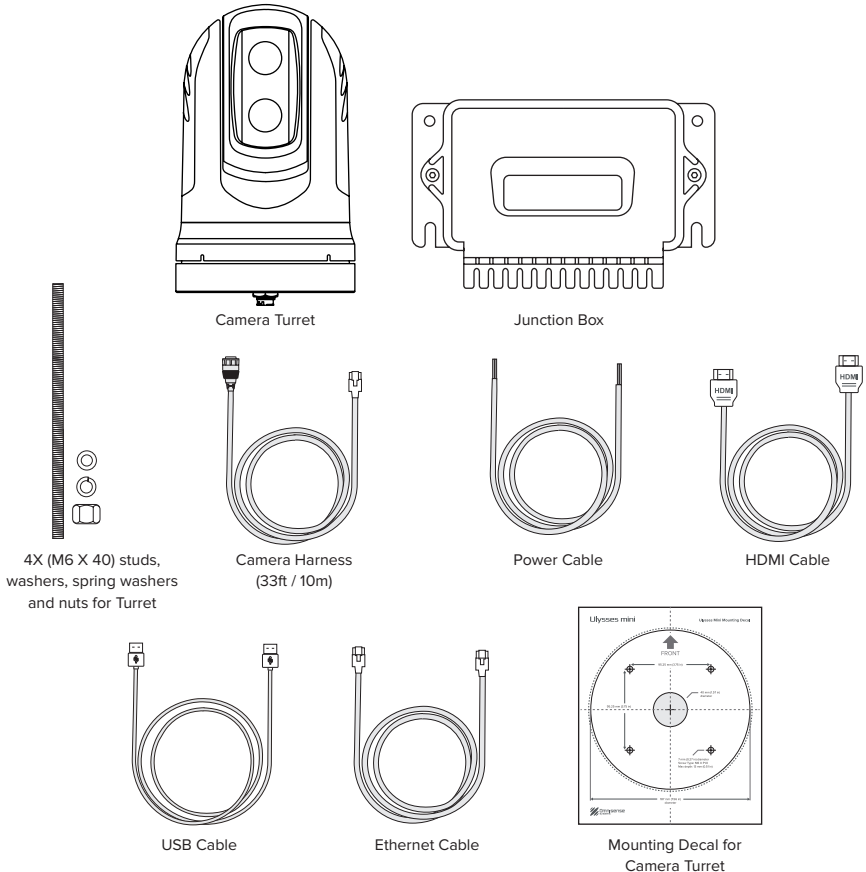

2.3 Optional accessories

The Joystick Controller, Riser, and a longer Camera Harness (100ft / 30m) can be purchased separately to be incorporated into a new or existing system as per your requirements.

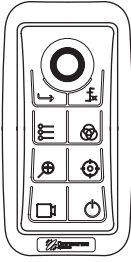

Joystick Controller

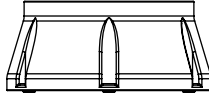

Riser

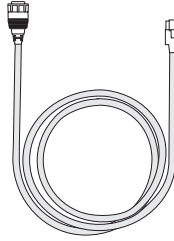

Camera Harness
(100ft / 30m)

2.4 Installation tools requirements

The following are additional tools and items required for installation that are not included in the package.

1. Drill
2. Jig Saw
3. Drill bit - 0.27in (7mm)
4. Drill bit - 0.23in (6mm)
5. Hole Saw - at least 1.57in (40mm)
6. Screwdriver
7. Hex key (Allen key) size 4 (for securing/removing the Junction Box cover)
8. Wrench size 8 (for securing the Controller studs)
9. Cutter (for removing excess ends of the cable ties)

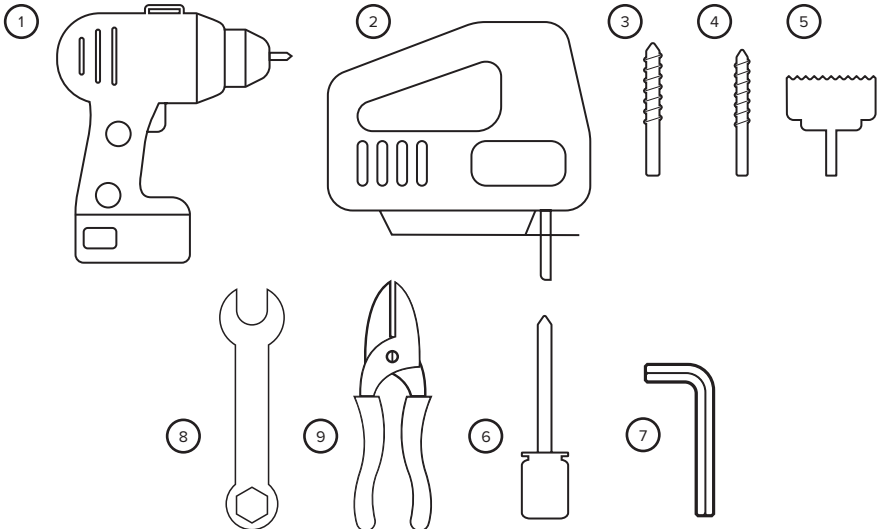

2.5 Getting to know the camera

Take a few moments to familiarize yourself with camera controls and displays. You may find it helpful to bookmark this section and refer to it as you read through the rest of the manual.

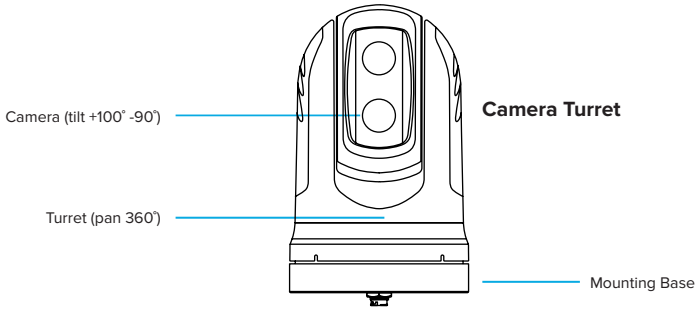

Junction Box

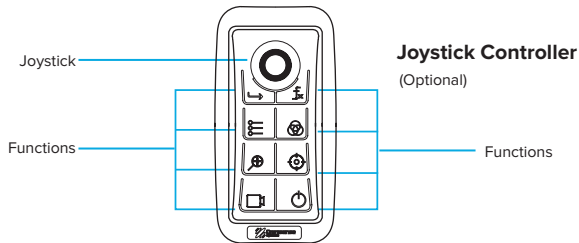
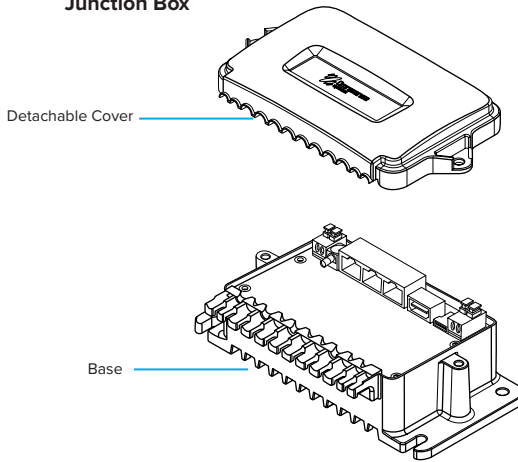

03 - Installation & setup

3.1 Installation checklist

The installation of the system will include the following tasks:

1. Planning your system setup
2. Prepared all required tools and items
3. Site the individual equipment
4. Route the cables
5. Create the opening for the Joystick Controller
6. Drill the mounting and cable holes for Camera Turret
7. Connect the cables to the products
8. Secure all products in place
9. Power on and test the system
10. Perform cable management

3.2 Cable management

Cable routing must be conducted correctly to maximize the performance and shelf life of the cables. Do not bend the cable excessively. Please ensure that a minimum bend radius of 3in (150mm) is achieved.

Protect all cables from physical damage by using trunking or conduit where possible. Do not run cables through bilges, doorways, hatches, and hot objects.

Always route data cables far away from other equipment and cables, high current carrying AC/DC power lines and antennas.

3.3 Layout & location

Before you commence the installation, it is important to produce a schematic diagram. The diagram will be handy for any future maintenance or upgrades to the system. The diagram should include the location of all components, cable types, routing, and length.

This is the layout plan (Fig. 1) of how your Ulysses Mini system will be set up.

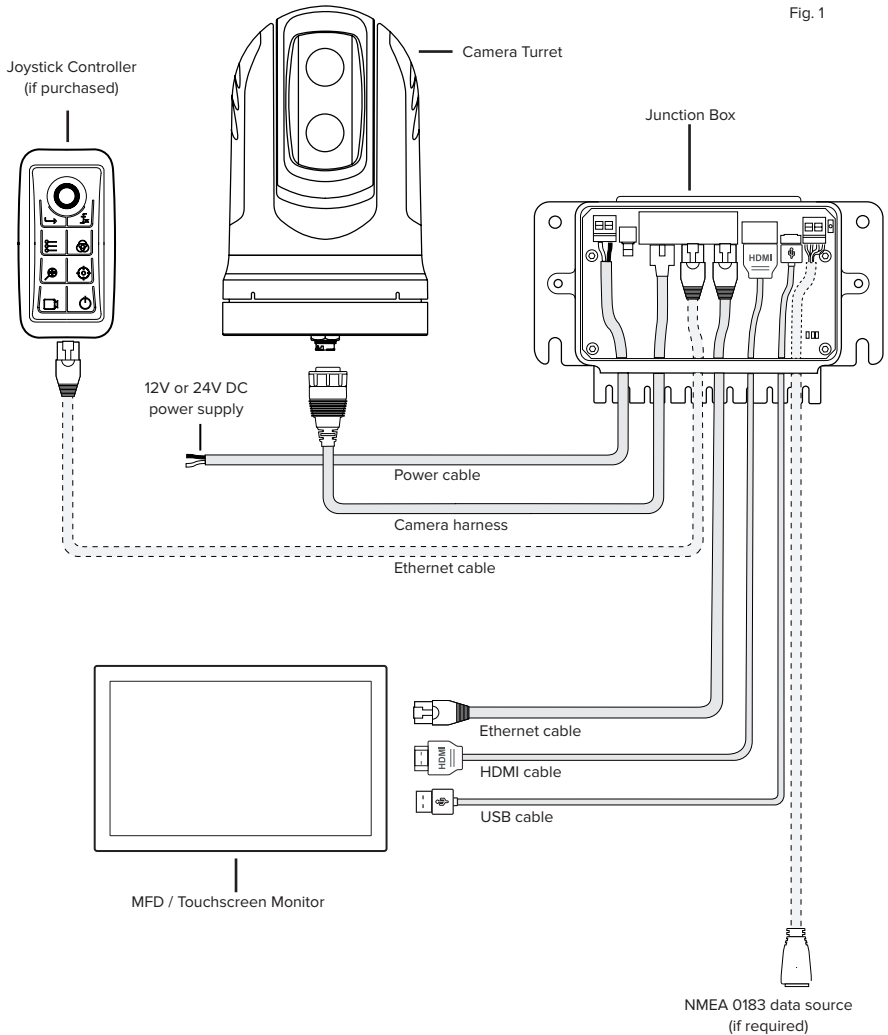



Fig. 1

Identify a suitable location to mount your Camera Turret. Ideally, it should be installed:

- above the bridge of your vessel,
- the mast or
- a location as high as practicable that offers/or close to 360° unobstructed views.

Alternatively, you may decide on a location that can offer the best view that you desire.

 Note that the Camera Turret can be mounted ball-up (upright) or ball-down (upside-down) position.

Other points to consider for the installation of your products include:

- The mounting surface must be horizontal and flat.
- Choose a location as close to the vessel's centerline as possible. This provides a symmetrical view when looking forward or aft.
- Ensure that the Camera Turret is installed in an accessible location for periodic cleaning (fresh-water rinse), inspection of mounting point integrity, mechanical soundness, and preventive maintenance.
- Camera Turret's mounting point should be sturdy and free from excessive vibration.
- The Camera Turret should be mounted as high as practical but without interfering with any radar, navigational, or communications electronics.
- Omnisense Systems products conform to the appropriate Electromagnetic Compatibility (EMC) regulations. To minimize electromagnetic interference between equipment, we recommend that wherever possible, Ulysses Mini equipment and cables connected to it are:
 - at least 3ft (1m) from any equipment transmitting or cables carrying radio signals. e.g., VHF radios, cables, and antennas. In the case of SSB radios, the distance should be 7ft (2m).
 - more than 7ft (2m) from the path of a radar beam. A radar beam can be assumed to spread above and below the radiating element.

3.4 Mounting the Camera Turret

The Camera Turret holds the imaging module, optics, and Pan/Tilt platform. The Camera Turret can be configured to be installed ball-up (upright) or ball-down (upside-down) position. But, first, identify and select a position with a clear line of sight to the intended observation area. The mounting location should also be secure and free from excessive vibration.

1. Take note of the orientation of the Camera Turret and place the base forward-facing relative to the bow of your vessel (Fig. 2). There is an arrow mark at the base of the Camera Turret indicating the forward-facing of the turret for installation. In most cases, this arrow should point toward the general direction of the vessel's bow.
2. Using the Mounting Template or Mounting Decal provided, mark and drill the 0.27in (7mm) holes required for attaching the Camera Turret.
3. Place your Camera Turret base over the screw holes and secure your Camera Turret with the four M6 studs, washers, spring washers, and nuts provided. Note that the thread holes at the turret base have a maximum depth of 0.5in (13mm). We recommend a length of between 0.3-0.4in (8-10mm) with a thread pitch of 1.0. At no time should the studs penetrate more than 0.5in (13mm) from the base (Fig. 3).
4. Ensure also that you insert the studs correctly and do not cross-thread. Such damages are not covered under warranty.
5. Take the Camera Harness, run it through the central hole, and connect it to the connector at the base of your Camera Turret.

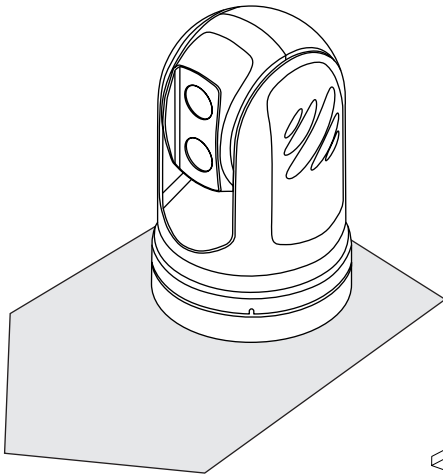

Fig. 2

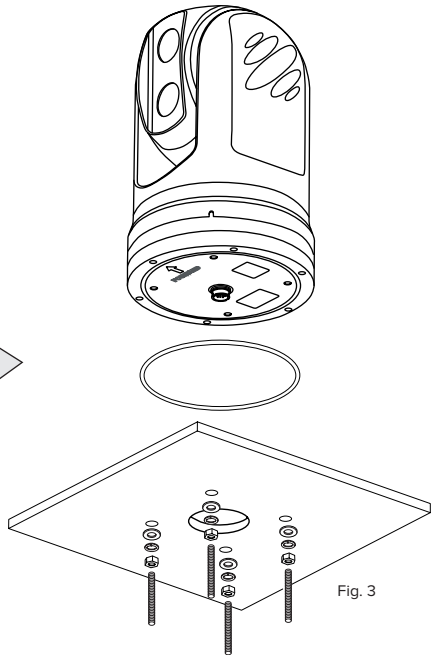

Fig. 3



Ensure depth of screws used do not penetrate more than 0.5in (13mm) from the base. Failure to observe this may severely damage the product.

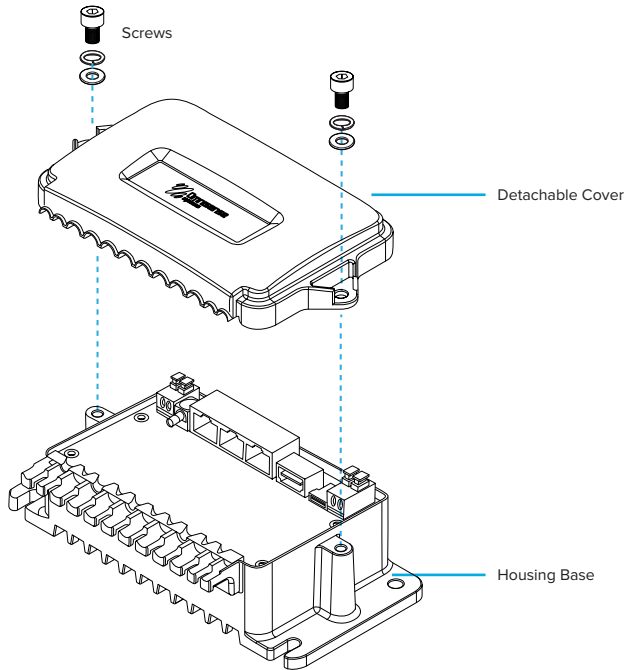

Fig. 4

3.5 Installing the Junction Box

The Junction Box is the main interface that handles communication between the components. It also distributes the power supply to the Camera Turret and the Joystick Controller.

The Junction Box consists of the housing base, a see-through polycarbonate cover, and two M5 studs secure it on each side of the box. To access the internal sockets, remove the retaining fasteners and the polycarbonate cover (Fig 4).

Create necessary openings for cables on the weather rubber seal found at the cable seat.

Once cabling connections are completed, replace the polycarbonate Junction Box cover. Cables can be further secured to the cable seat by the cable ties provided.

 Please note that the Junction Box is not weatherproof and should be installed in an area protected from the elements.

 We recommend installing the Junction Box onto a bulkhead with a cable outlet facing down and within a reasonable connecting distance to the displays/MFDs and joystick if used.

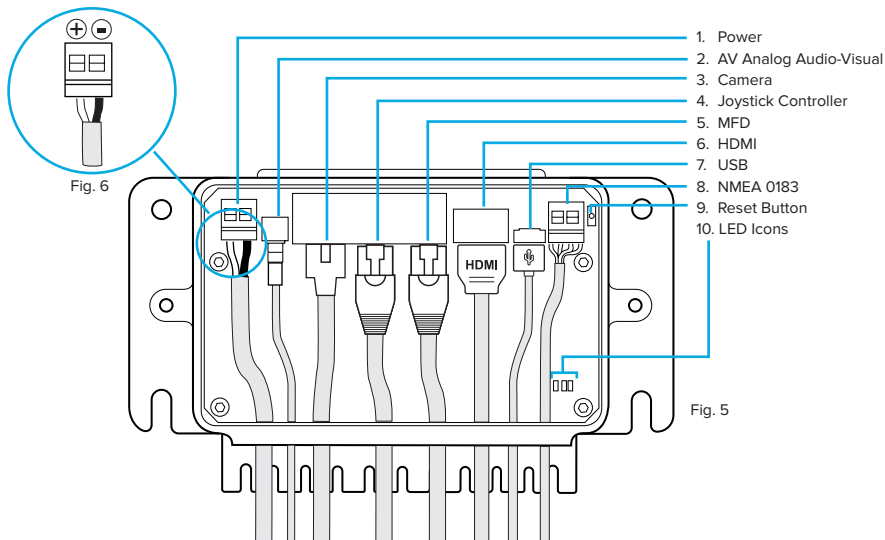

Junction Box

The Junction Box is the primary means to provide power to the Camera and Joystick Controller. It also serves as a hub for data transmission and interfacing point to other connected network devices (Fig. 5).

1. **Power cable** - Connect the power cable provided to the [Power] port in the Junction Box and to a DC power source on your vessel. It is recommended that you use either a 12V or 24V DC power. The power cable consists of Black for (-) negative, White for (+) wire. Please ensure that the correct polarity is inserted into the right terminal (Fig. 6).
2. **AV Analog cable** – If you are using an analog monitor, connect one end of the AV Analog cable to the [AV] port in the Junction Box and the other end to an analog monitor.
3. **Camera harness** - Connect the end of the camera harness to the Ethernet port in the Junction Box marked [Camera].
4. **Controller cable** - Connect the Ethernet cable to the Junction Box [Controller/MFD] port and the other end to the Joystick Controller (if purchased).
5. **MFD cable** - Connect one end of the ethernet cable to your MFD and the other to the Ethernet port on the Junction Box marked [Controller/MFD].
6. **HDMI cable** - Connect the HDMI cable to the HDMI input port and the other to a supported MFD / Touchscreen monitor.
7. **USB cable** - Connect the USB cable to the USB input port and the other to a supported MFD / Touchscreen monitor.
8. **NMEA 0183 socket** - For devices that require input from NMEA 0183 devices, connect the NMEA 0183 data source to the [NMEA] socket in the Junction Box using 24-20 AWG cables and the output from the NMEA device to the Rx pins in the Junction Box
9. **Reset Button** - Press the reset button for 10 sec to reset the Junction Box to the default IP. To re-connect the Junction Box to the system, you must set the camera's IP back to the default IP. The equipment should be connected thereafter.
10. **LED Icons** - The LED icons provide you with a visual indication of the functioning of the equipment connected to the Junction Box. Please refer to the Troubleshooting guide in Chapter 8 for explanations on the LED icons.

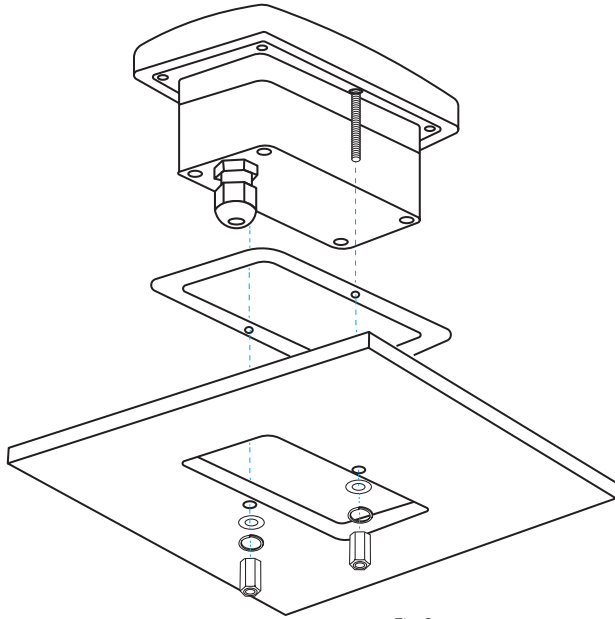

Fig. 8

3.6 The Joystick Controller

The Joystick Controller (Fig. 8) is the physical controller for the camera system. It is meant to be panel mounted. If correctly installed, the top side of the Joystick Controller is waterproof and suitable for open deck installation.

Identify and select an installation position that provides the best ergonomics for controller operation. The housing of the Joystick Controller is designed to provide a stable grip while the thumb and index fingers move the knob.

1. The Joystick Controller has a flush back that can be easily fitted onto any flat surface. Select a suitable location close to your MFD/Monitor.
2. Using the Joystick Controller Mounting Template, mark and cut out the space to mount the Joystick Controller.
3. Drill the 6mm holes required for attaching the Joystick Controller.
4. Mount the Joystick Controller and use the bolts provided to secure it in place.
5. Connect one end of the Joystick Controller Cable to the [Controller] port in the Junction Box and the other end to the Joystick Controller.
6. To pair your Joystick Controller with the Camera Turret, see section 5.5.7.

3.7 Connecting to your display options

You can choose to display the video output of your Ulysses Mini to a supported MFD via IP (Ethernet) or HDMI to a Touchscreen monitor/MFD. We recommend using the HDMI option when using a higher resolution camera for better video performance.

3.7.1 Connecting to your MFD

Connect the Ethernet, HDMI, and USB cables from the respective ports in the Junction Box to a compatible MFD. The Camera will work with Garmin MFDs with OneHelm by default. If you are using a *Garmin MFD, you should see a Ulysses Mini icon displayed on the 'OneHelm' page after powering up the MFD and camera system. Launch the Ulysses Mini icon to use the Camera.

If you are using a Furuno or *Navico MFD, you will need to configure the camera system to communicate in the correct network environment using either a web browser or an analog monitor and Joystick Controller. Refer to sections 3.7.2 and 3.7.3.

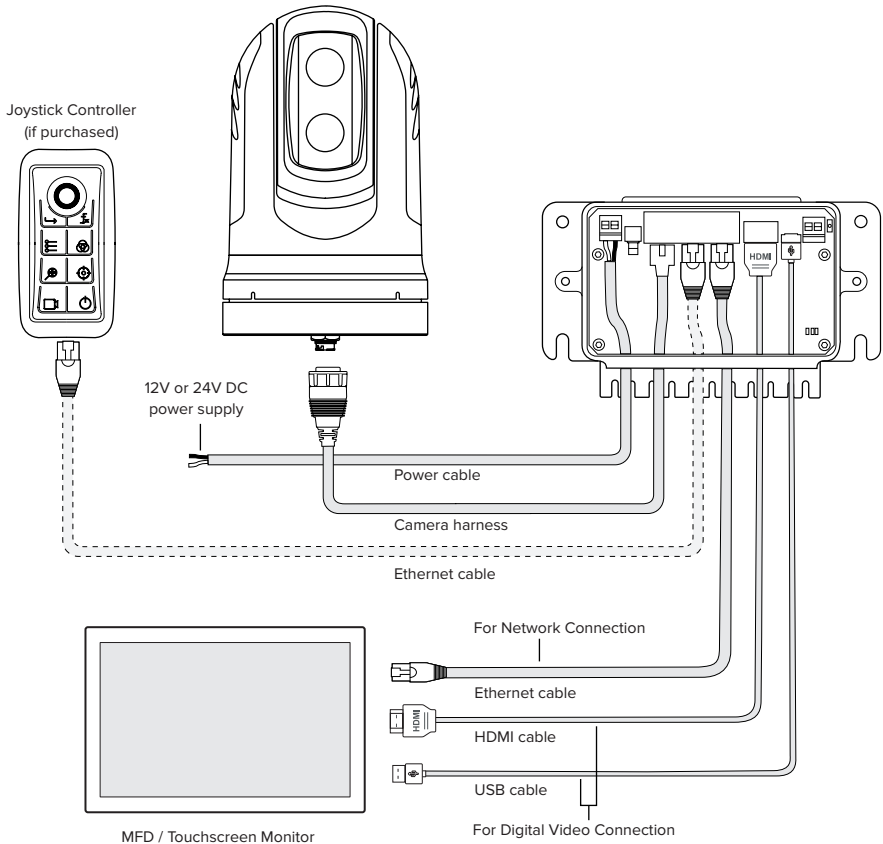

3.7.2 Connecting to a laptop/desktop

Connect an Ethernet cable from your PC to the Ethernet port on the Junction Box marked [Controller/MFD]. Then, on your web browser, enter the default IP address as indicated at the base of the turret and log in with the following:

Username: admin
Password: 12345

You can now access complete control of the Camera through the Web browser.

 Your laptop/desktop network connection needs to be configured with the same IP range as the Camera (see section 3.8).

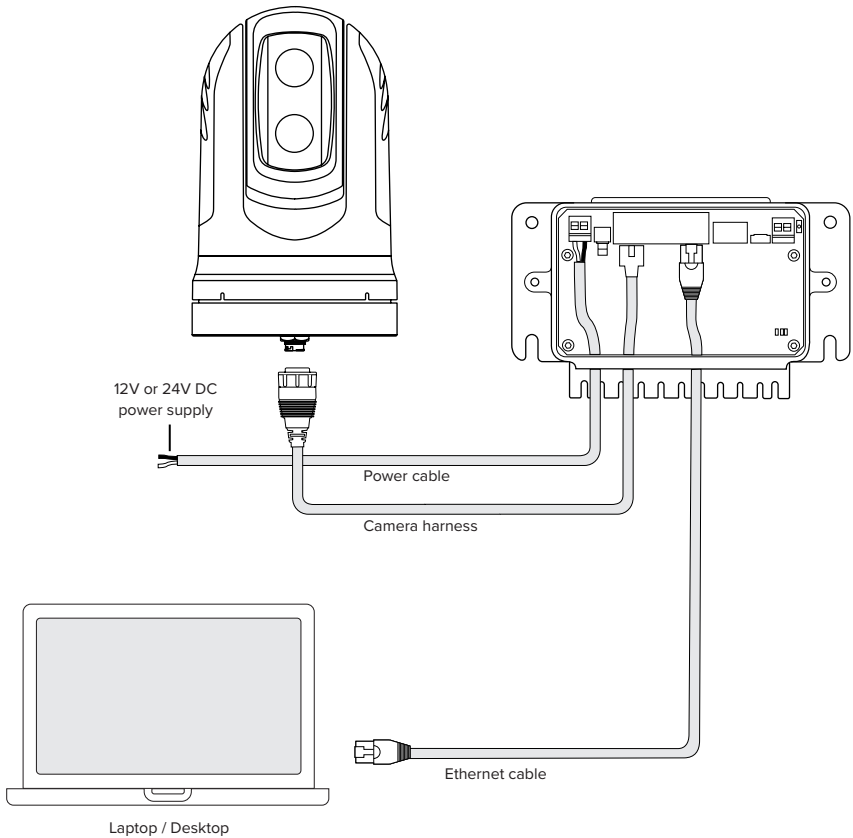

3.7.3 Connecting to an analog monitor

Connect the AV analog cable to your analog monitor from the [AV] port in the Junction Box. The display will appear on the screen. Use the Joystick Controller to control the camera.

You will require the Joystick Controller to operate the system for this setup option.

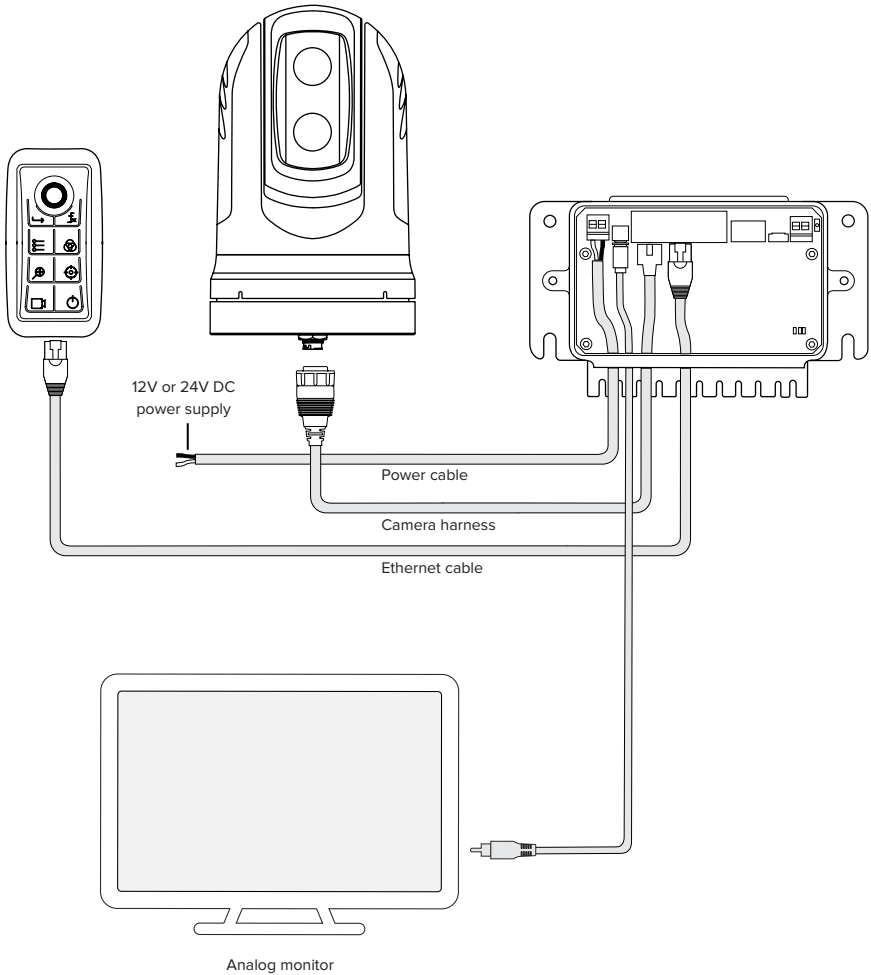

3.8 Change IP Settings

If you cannot connect to the camera due to a different set of IP addresses, follow this step to configure the camera for Windows users.

1. Go to Settings, then click on Network & Internet.
2. Right-click on your Ethernet Network connected to the Junction Box and click on Properties (Fig. 9).
3. On the properties screen, select Internet Protocol Version 4 (TCP/IPv4) and click on Properties (Fig. 10).

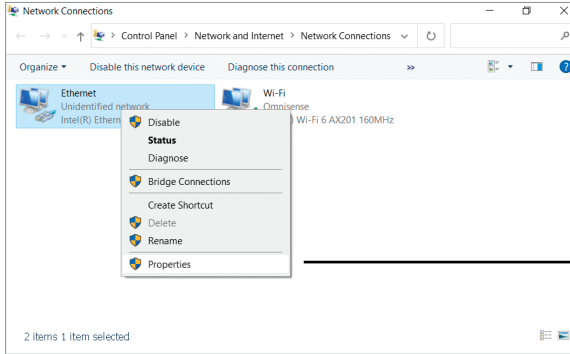

Fig. 9

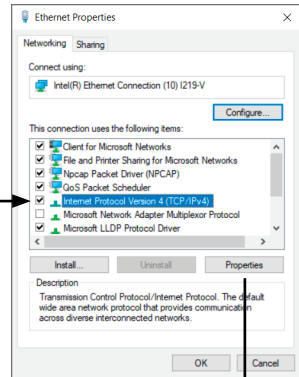

Fig. 10

4. On IPv4 properties screen, select Use the following IP Address option (Fig. 10).
5. Enter the following IP address: 172.16.6.xxx (any number except 225). As you can see in the above image (Fig. 11), the first 3 number sets (172.16.6) in the IP Address field need to be the same as the Junction Box IP address. You can only change the last number set with any number from 1 to 254. Click in the Subnet Mask area, which should auto-complete. Click OK (Fig. 11).
6. Launch your web browser and enter the following address <http://172.16.6.225/> and login with the following:

Username: admin
Password: 12345

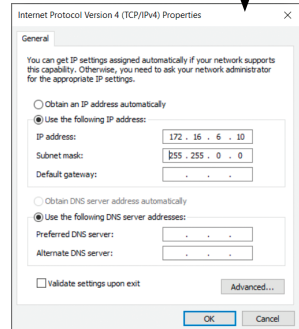

Fig. 11

7. Full control of the camera can be accessed through the Web Interface. You can configure the IP address to connect to your MFD from the Settings menu.

04 - Operations

4.1 Powering-up

The Ulysses Mini system automatically powers up when connected to your vessel's power.

1. Ensure that you have connected the Camera Harness to the Camera Turret.
2. Ensure that your network cable and video output are connected, and your display is powered on.

Upon powering up for the first time, the system will automatically search and connect to the Camera Turret.

If the system is unable to connect to the Camera Turret, it may be due to one of the following:

1. The Camera Turret and the Junction Box are not set to the default IP address.
2. The Camera Turret and the Junction Box are not configured within the same IP range.

Select the [Search] button on the screen to scan for the Camera Turret connected within the network. The system will list out the Camera Turret's serial number. Select the **+** button next to the camera's serial number to connect to the preferred Camera Turret.

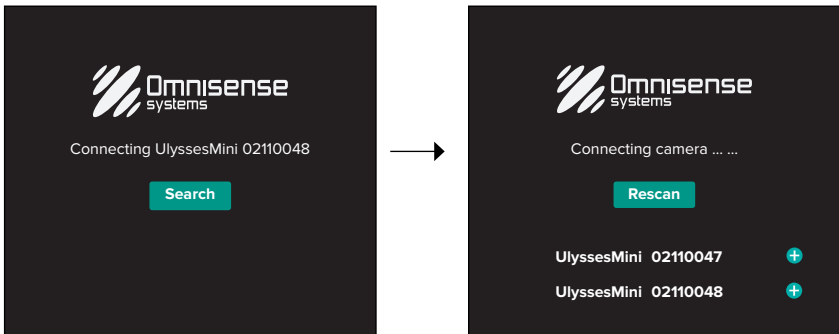

 Once the Junction Box has been connected to a Camera Turret, the system automatically connect to the same Camera Turret on subsequent powering up.

 The system will configure the Junction Box's IP address to match the IP range of the Camera Turret. The third set of the Junction Box's IP address will be configured to an incremental of three. For example, if the Camera Turret IP address is 172.16.6.225, the Junction Box's IP will be configured to 172.16.9.225.

4.2 Login to camera

You will need to log in when connecting the camera system to an MFD or PC/Laptop browser. Upon powering up, the login page will be displayed as shown below. Enter the password to access the user interface. The default password is "12345".

There are no requirements to log in if you use an HDMI or analog monitor.



Username

Password

LOGIN

4.3 Gyro calibration

The system will automatically initiate a gyro calibration sequence after powering up or waking up from Standby mode. A “gyro calibrating” message will be displayed on the screen when calibration is in progress.

- If gyro calibration is successful, a “Gyro calibration successful” message will be displayed. Select [OK] on the dialog box to confirm.
- If gyro calibration is unsuccessful, a “Gyro calibration unsuccessful” message will be displayed. To perform gyro calibration again, select [Calibrate] on the dialog box. Alternatively, you may select [Cancel] to exit the dialog box.

When the system detects that a gyro calibration is required, a “Gyro calibration required” message will be displayed on the screen.

- To perform gyro calibration, select [Calibrate] on the dialog box.
- Alternatively, you may select [Cancel] to exit the dialog box.

Stabilization function will not be available if the gyro is not calibrated properly.

If the gyro has not been calibrated properly, the “gyro cal required” message will appear whenever the user wishes to enable the stabilization function.

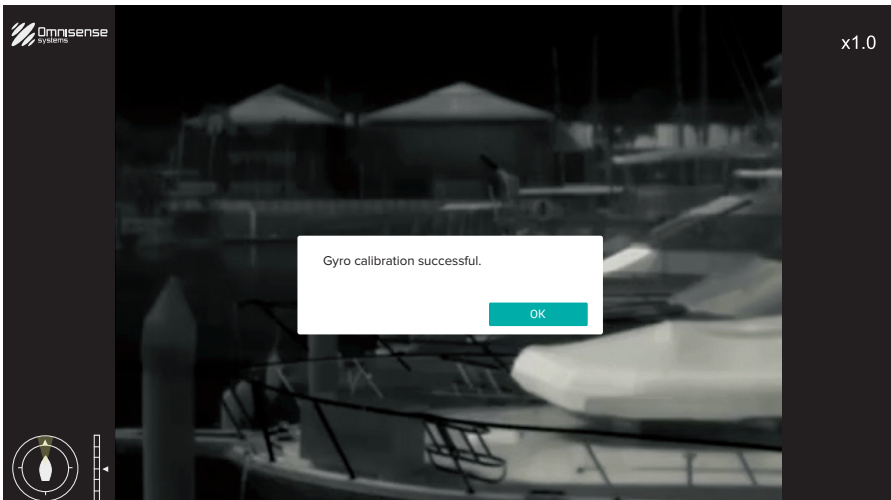

4.4 Thermal display image

The camera outputs can be displayed on a compatible Multi-function display (MFD), an HDMI monitor, or a desktop/laptop via a web browser.



 Take some time to familiarize yourself with the thermal image on your display. This would allow you to utilize the system effectively.

Points to take note about viewing thermal images:

1. Consider every object you view in terms of how it will look “thermally” as opposed to how it looks to your eye. For example, look for changes caused by the sun’s heating effect. These are particularly evident right after sunset.
2. Experiment by looking for hot objects (such as people) compared to the colder surroundings.
3. Experiment with the camera for daytime viewing. The camera can provide improved daytime viewing in environments where traditional video camera performance suffers, such as in shadows or backlit scenes.

The thermal display image includes icons to indicate the current status of the camera.

4.5 Operating the camera

The camera functions can be accessed directly from your Multi-function Display (MFD), Touchscreen monitor, or web browser.

If you are using an MFD

Tap anywhere on the screen to display the Quick Menu and the Virtual Joystick.





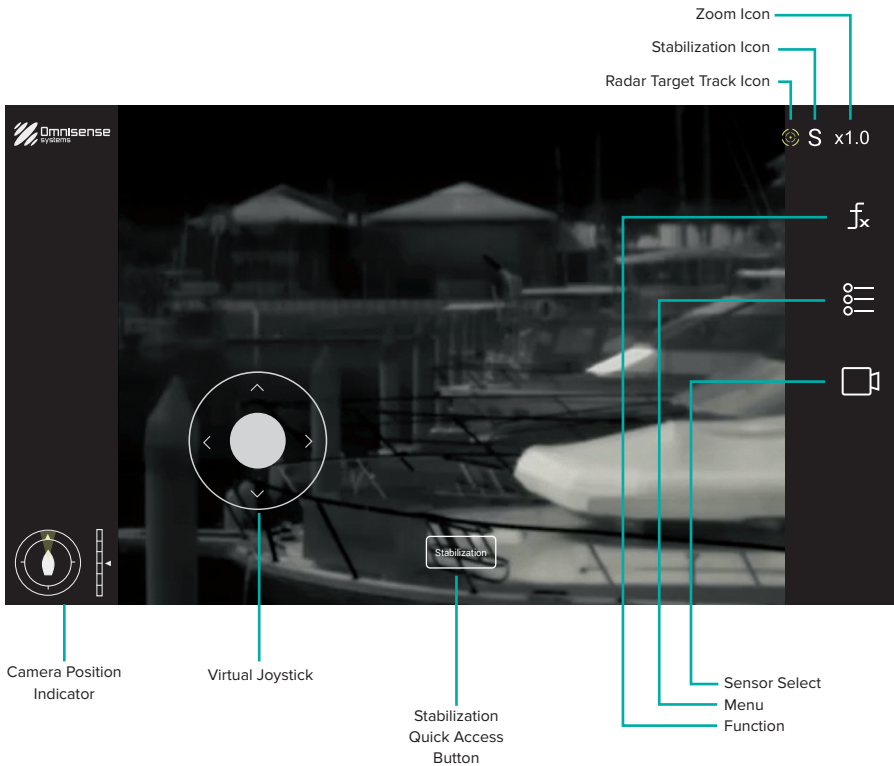

If you are using a web browser

Use your mouse to click anywhere on the screen to display the Quick Menu and the Virtual Joystick.

The Quick Menu and the Virtual Joystick will disappear after 3 seconds of inactivity.



The display screen comprises of the following icons:

Icon	Description
	<p>Camera Position Indicator The triangle segment inside the circle indicates which direction the camera is pointing with respect to the vessel. The scale and marker on the right show the camera's tilt angle.</p>
<p>x1.2</p>	<p>Zoom Icon Displayed whenever the image is magnified from 1.0 to 4.0X. (for the thermal image only)</p>
	<p>Virtual Joystick To direct or point the camera to the intended direction and/or object, Select and drag the middle button on the Virtual Joystick towards the intended direction.</p>
	<p>Function Quick access function that can be programmed for Home, NUC, Standby and Radar. The default function is set to NUC (see section 5.3.1 to understand NUC). See section 5.5.6 to learn how to program the shortcut key.</p>
	<p>Menu Menu access to the camera system functions and settings.</p>
	<p>Sensor Select Toggle between thermal and day view.</p>
	<p>Stabilization Quick access button to activate the Stabilization or Heading Lock mode. The first click/selection activates the Stabilization mode, while the second click/selection activates the Heading Lock mode. Once active, the respective icon, Stabilization S or Heading Lock H will appear on the top right corner of the screen. See sections 5.4.1 and 5.4.2 for more details.</p>

4.6 Camera control

The Virtual Joystick and/or the knob on the Joystick Controller (if purchased) controls all panning and tilting operations of your Turret and Camera.



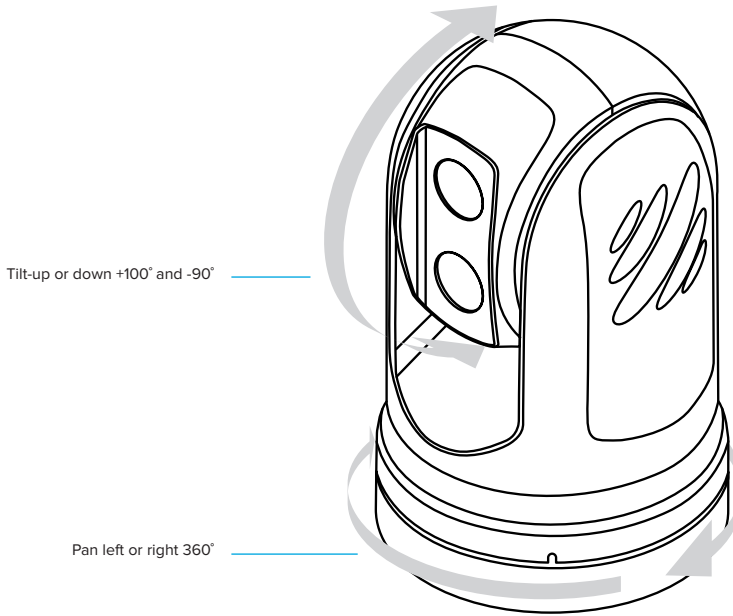



Use the Virtual Joystick or Joystick Controller to pan (turn left or right) and tilt (up or down) the camera to search and acquire a visual on your target.



05 - Menu

Select  to access the functions and settings of the camera. The list of menu icons will appear on the right of the screen. Select a menu icon on the display or Joystick Controller to access the respective function listed on the table below.



	Color Palette	Select from 6 different color palettes See section 5.1 for more details
	Zoom	Zoom level from 1.0 to 4.0X See section 5.2 for more details
	Brightness & Contrast	Adjust image brightness and contrast See section 5.3 for more details
	Radar Track / Stabilization	Radar Slave (Slew-to-Cue), Radar Target Track, Stabilization, and Heading Lock See section 5.4 for more details
	Settings	Access to camera's settings See section 5.5 for more details
	Home / Standby	Camera position, Standby and Wake up See section 5.6 for more details

5.1 Color Palette

Select  to access the Color Palette. Select your preferred color scheme from the 6 different color modes available. Tap or click anywhere on the screen to exit the menu. If using the Joystick Controller, select by moving the knob up or down.

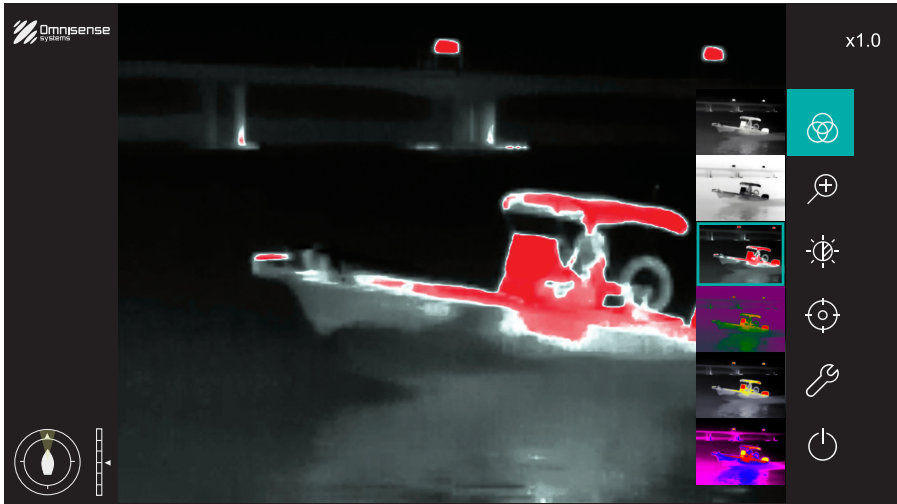

Color	Feature
White Hot	Light colors for hotter objects/regions Default mode for the IR display
Black Hot	Inverted version of White Hot Dark colors for hotter objects/regions
Highlight	Selected color gradient for greater contrast between regions
Night Running	For better viewing comfort during low light conditions
Flame	For greater contrast across a narrow range of temperature
Psychedelic	Rich saturated colors with glaring contrast

5.2 Zoom

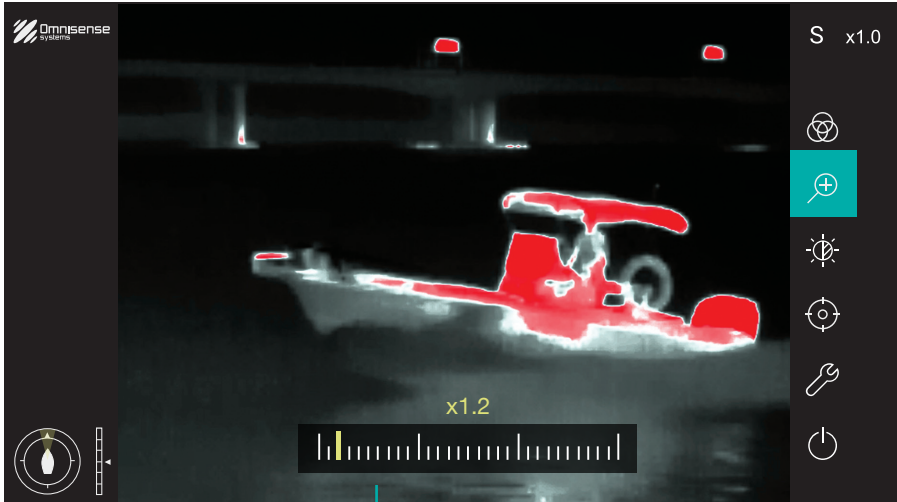

The Ulysses Mini features a fix-focus imaging sensor that can zoom into target objects with up to 4.0X magnification.

- Select  to activate the zoom slider.
- Move the slider to the left or right to control the amount of magnification.
- Tap or click anywhere on the screen to exit the menu.



Zoom slider

5.3 Brightness & Contrast

1. Select  to activate the function.
2. Move the Brightness slider left or right to control the amount of brightness.
3. Move the Contrast slider left or right to control the amount of image contrast.
4. Select anywhere on the screen or press  on the Joystick Controller to exit menu.

5.3.1 NUC

The non-Uniformity Correction (NUC) function corrects for slight detector drift that occurs due to changes in the surrounding temperature and environment. As the heat emitting from the camera can interfere with its performance, the NUC function allows the camera to adjust the image based on its own IR radiation readings.

The Non-Uniformity Correction (NUC) function is activated by default during the initial startup and remains active in real-time for maintaining image quality. Should the image quality appear unsatisfactory, you can activate the NUC function manually by pressing the [NUC] button.

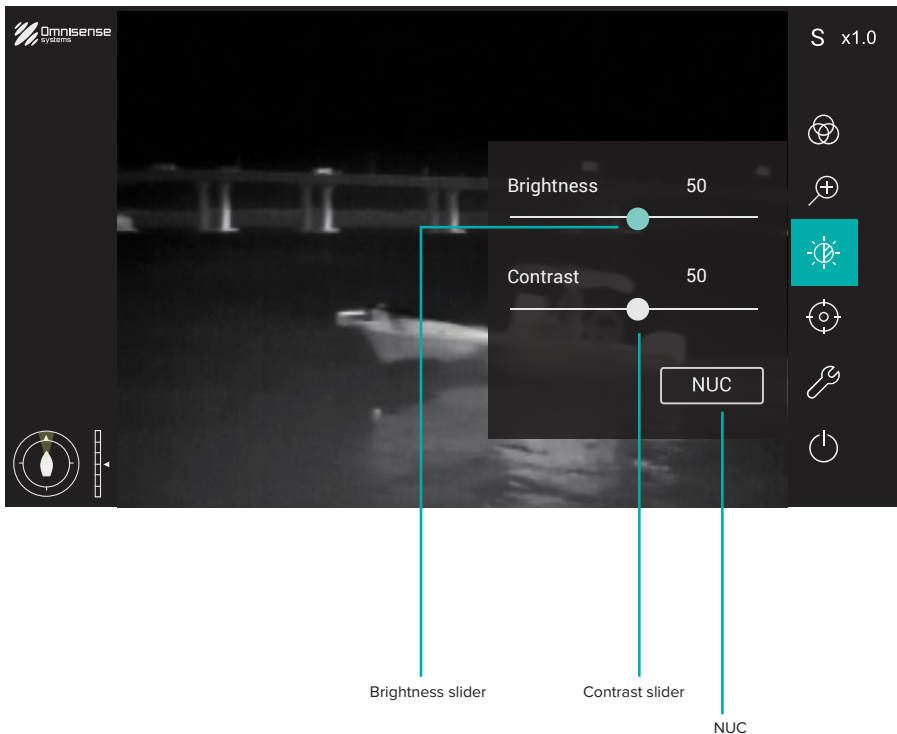

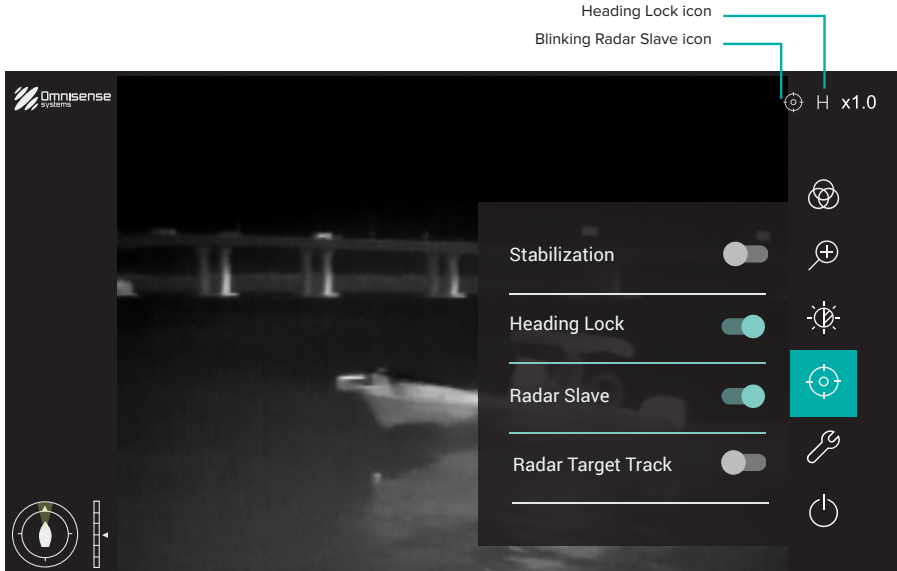

5.4 Radar Track

Select  to access Radar Track settings. Both [Stabilization] and [Heading Lock] modes are designed to maintain stability and quality of the image when encountering excessive movement.





5.4.1 Stabilization

Stabilization mode provides dual-axis stabilization that enhances overall image stability. When activated, the camera will remain pointed in the same direction irrespective of any directional changes to the vessel. The inbuilt gyro-stabilization technology counteracts excessive ship motion caused by wave actions or vessel movement, ensuring the image quality remains crisp and clear.

To activate Stabilization mode, slide  to the right. An  icon will appear at the top right corner screen, indicating that the Stabilization mode is now active.

5.4.2 Heading Lock



Heading Lock mode provides tilt (up and down) stabilization for enhancing image stability as the vessel moves and turns. The camera is not locked onto a fixed point, unlike in full stabilization mode.

To activate Heading Lock mode, slide  to the right. An  icon will appear at the top right corner of the screen, indicating that the Heading Lock mode is now active.

 Only one stabilization mode can be activated at any given time.

5.4.3 Radar Slave (Slew-to-Cue)

When interfaced with a compatible radar, the Radar Slave (Slew-to-Cue) function allows your camera to slew to the target azimuth on the cursor location.

To activate Radar Slave mode, slide  to the right. A blinking  icon will appear at the top right corner of the screen.



To visually acquire target with the Radar Slave mode:

- On the radar display, move the cursor to the desired location.
- The camera will slew to the selected direction, and the target will be shown on the display if the target is within the performance range of the camera.

To deactivate radar tracking, slide  to the left.

5.4.4 Radar Target Track

The Radar Target Track mode allows your camera to slew to and track the target you selected on the radar.

To activate Radar Target Track mode, slide  to the right. The Track shortcut button will appear on the quick menu when TTM sentence is applied. When you click on this shortcut button, a blinking  and  icon will appear at the top right corner of the screen. The Stabilization mode will automatically be activated with the Radar Target Track mode.

To visually acquire the target with the Radar Target Track mode:

- Select target from the radar on your Multi-function Display (MFD).
- The camera will slew to the selected target, and continuously track the target on the system even if the target is moving.

To deactivate radar tracking, slide  to the left.

 Full stabilization will be enabled automatically whenever the Radar Target track function is enabled.

 Radar Slave (Slew-to-Cue) and Radar Target Track function are only applicable to Multi-function Display (MFD) with NMEA0183 RSD.

 Radar Target Track needs a TTM sentence along with ANY of the following sentences: THS, HDT, or OSD.

5.5 Settings

Select  to enter the Settings menu. The camera settings can be configured from this section and comprise the following topics:

1. Information
2. Device Access
3. Video
4. Position
5. Function
6. LED
7. Controller
8. Junction Box
9. NMEA

5.5.1 Information

The Information section provides an overview of the camera system configuration.

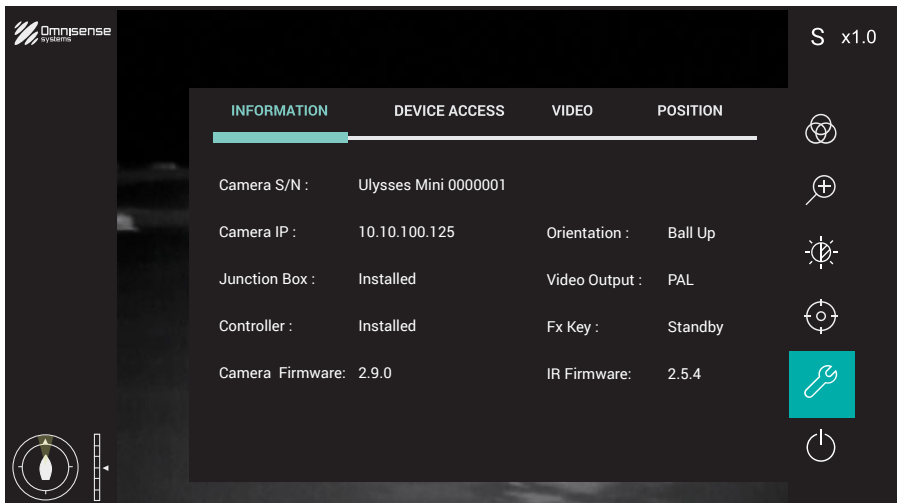

 The above values are for illustration purposes. The values shown on your system will vary.

5.5.2 Device Access

In this section, you can change the camera system's default password and IP address.

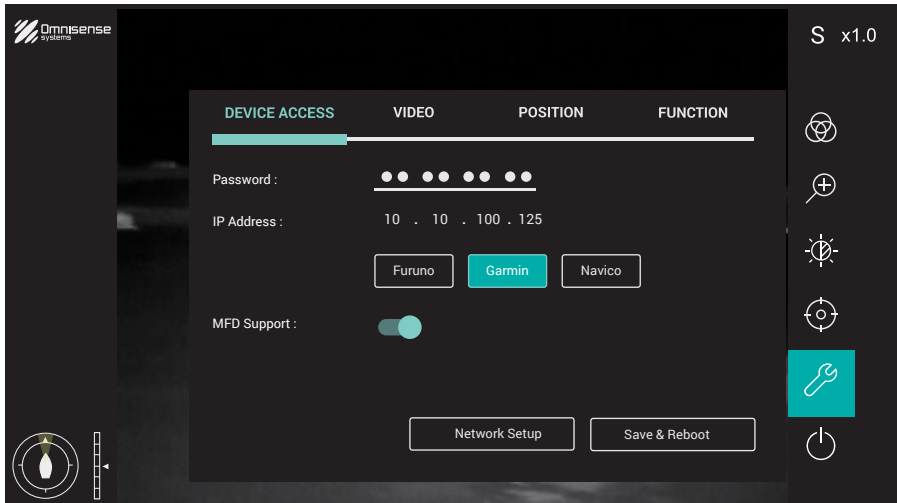

How to change the password

1. Select the password field (default password is 12345).
2. Enter your preferred password and click/tap anywhere on the screen.
3. Select [OK] on the dialog box to save your new password.

How to change the IP address

The IP address is set to configure for a Garmin MFD by default. However, if you are using a Furuno or Navico MFD, you can set the IP address to configure to one of the supported brands using the preset buttons. Then, the camera IP will automatically change to a matching IP similar to the IP domain of the respective supported brand.

To change the IP address for either Furuno, Garmin, or any Navico MFD:

1. Select on either [Furuno], [Garmin] or [Navico] button to generate a set of IP address.
2. Select [Save & Reboot]. Select [OK] on the dialog box to confirm.
3. The camera will be configured with your MFD after the reboot.

Changing the IP address manually



If there is a conflicting IP address with other connected devices within the network, you can manually change the camera's IP address (see Network Setup 5.5.3).

MFD Support

The system is compatible with most Furuno, Garmin, or Navico brand MFDs. The [MFD Support] is switched on by default. When you switch on the MFD and Ulysses Mini system, the MFD will automatically detect the camera and display the Ulysses Mini icon on the screen. You can launch the Ulysses Mini user interface (UI) by tapping/clicking on the icon.

 Do not turn off this function unless it's necessary, such as when you have multiple MFDs connected within the network.

To turn off/on the function:

1. Slide  right to turn on or slide  left to turn off.
2. Select [Save and Reboot] on the dialog box to confirm.
3. The new setting will take effect after the reboot.



Once the [MFD Support] function is switched off, the MFD will not be able to detect the camera or launch the app. To switch it back on, you will need to connect the camera to a computer/laptop and access this function [MFD Support] via a web browser.

5.5.3 Network Setup

In this section, you can manually configure the IP address, subnet mask, and gateway for your camera unit. Change the settings accordingly if they cause IP address conflict with other devices in your network.

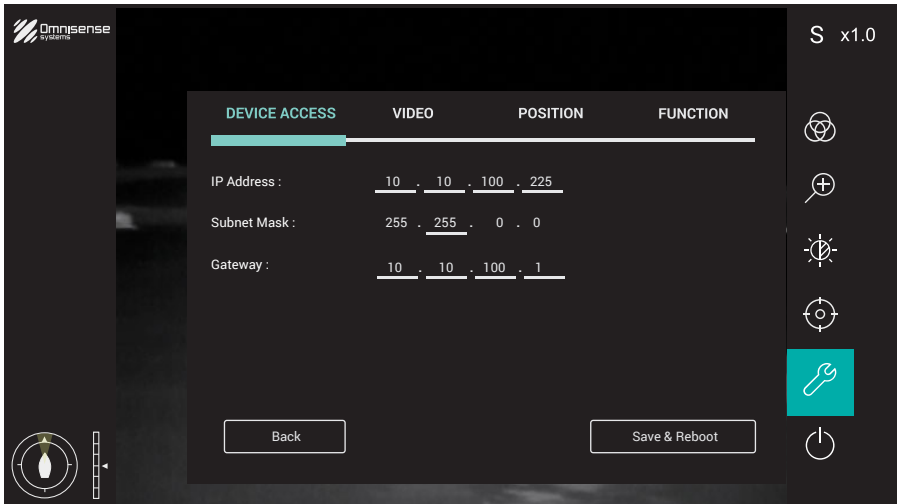

To change the IP address settings:

1. Select the IP field (IP Address, Subnet Mask or Gateway) that you wish to change.
2. Enter the preferred IP address.
3. Select [Save & Reboot]. Select [OK] on the dialog box to confirm.
4. The new settings will be registered after the reboot.

5.5.4 Video

In the Video section, you can change the Frame Rate (fps), Bitrate, and Video Output Format.

IP Frame Rate

There are three different video frame rates options: 3, 6, or 9. Selecting any of the options will activate it immediately.

IP Bitrate

Adjust the bitrate using the slider if you're having trouble with the video quality. Then, experiment and pick the optimal bitrate that yields an acceptable image quality.

Video Output Format

You can choose either PAL or NTSC format for analog video output. To select your option:

1. Select [PAL] or [NTSC].
2. Select [Save & Reboot]. Select [OK] on the dialog box to confirm.
3. After the reboot, the video output will be displayed in the new format.

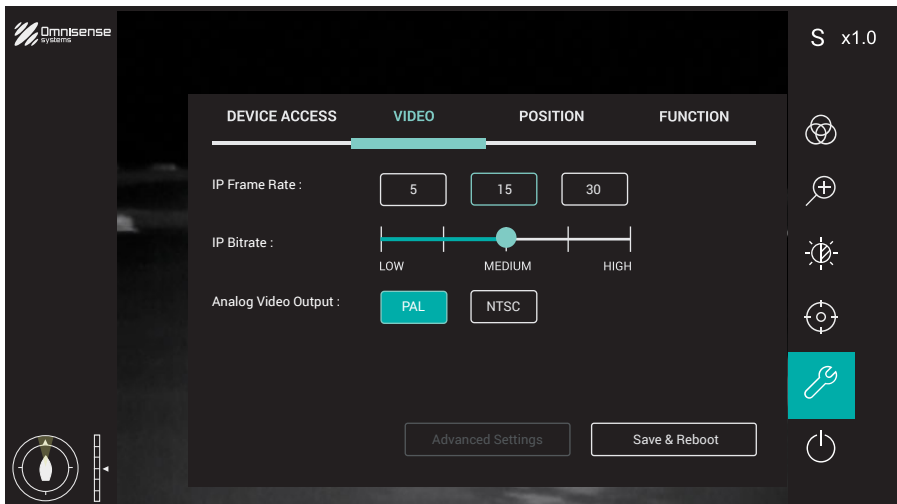

 Advanced Settings function is applicable for Day Camera only.

5.5.5 Position

In this section, you can change the Camera Orientation and set the Home Position. The Camera Turret will park the sensor lens down into park position when in Standby mode.

When your Camera Turret is mounted in the ball-up (upright) position, the sensor lens will face down. When your Turret is mounted in the ball-down (upside down) position, the sensor lens will face up.

Camera Orientation

Depending on how you have mounted your camera, you will need to select either [Ball up] with the Camera unit mounted “upright” or [Ball down] with the Camera unit “upside-down”.

1. Select the appropriate orientation [Ball Up] or [Ball Down].
2. Select [Save & Reboot]. Select [OK] on the dialog box to confirm.
3. The camera orientation will be registered and ready to be used.

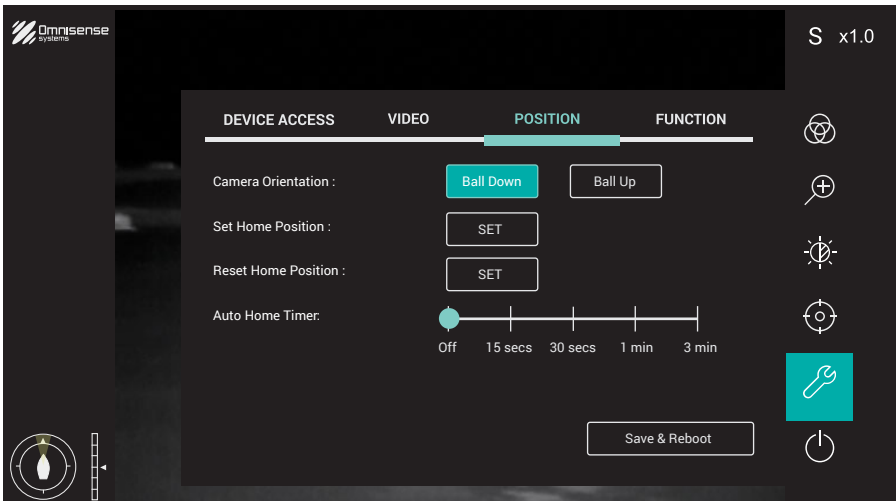

Set Home Position

The system has a function that allows you to preset your preferred offset pan and tilt position of the camera when the [Home] option is activated. To utilize this function:

1. At the Set Home Position field, select [Set].
2. Pan and tilt the camera to your preferred “Home” position.
3. Select ↩ to save the position or select ☰ to exit.

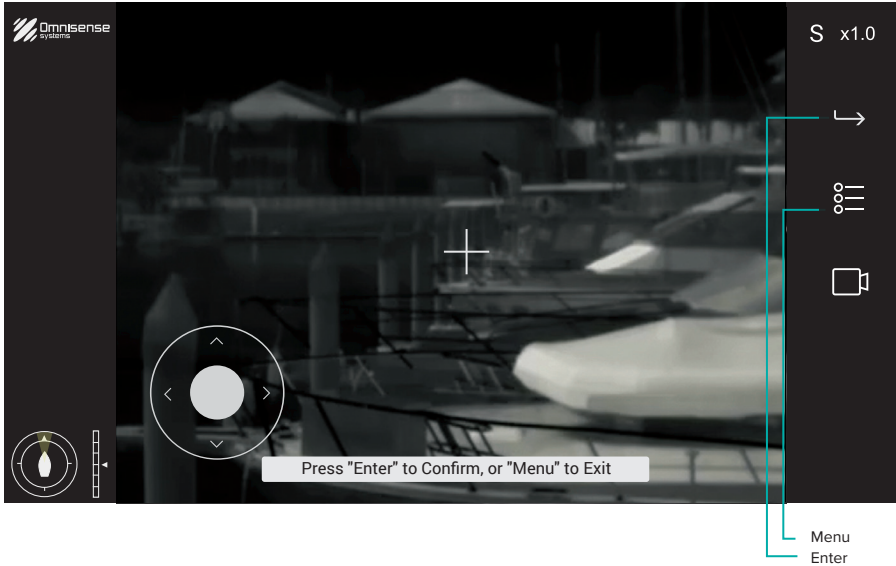

Reset Home Position

The [Reset Home Position] function resets the offset “Home” position back to the original factory settings. To reset the “Home” position to factory default:

1. At the Reset Home Position field, select [Set] once.
2. Select [OK] on the dialog box to confirm.
3. The original position is set to factory default.

Auto Home Timer

The [Auto Home Timer] function will return camera to the “Home” position when it reaches a specific period of inactivity.

5.5.6 Function

Fx Key

This function allows you to program a shortcut key to the **f_x** button. Select from one of the available functions: Home, NUC, Standby, or Radar to activate.

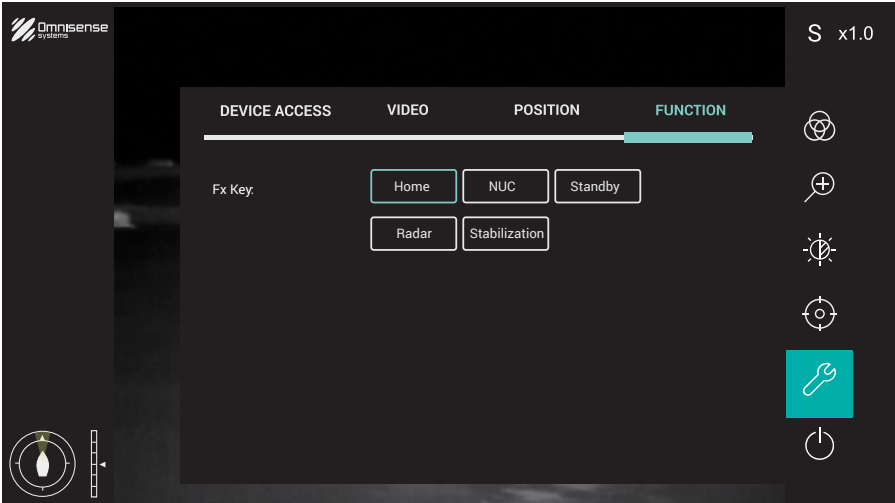

LED

The camera is pre-installed with variable color LED lighting. Select the preferred color from the seven-color preset.

For customization of the lighting's color, select the last color icon and adjust the slider for [Red], [Green], and [Blue] accordingly.

To change the intensity of the LED, simply shift the slider for [LED Brightness].

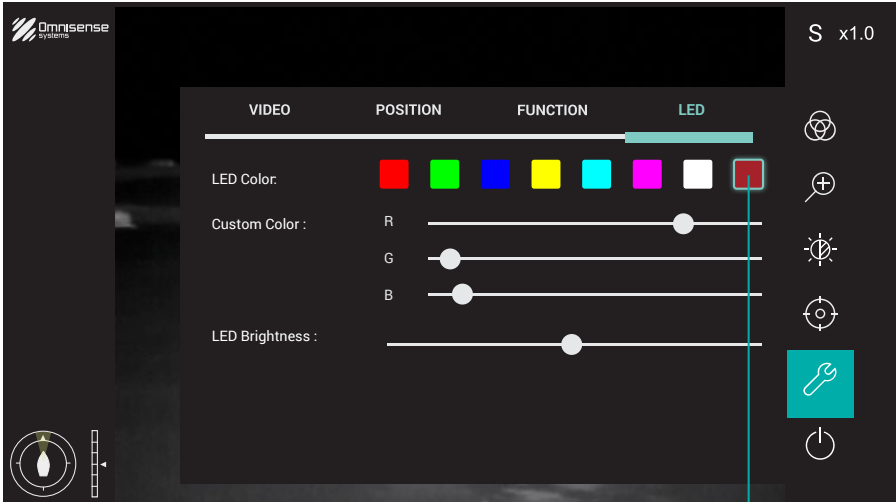

Select the last icon for color customization

5.5.7 Controller

In this section, you can connect to the Joystick Controller(s), set the IP address, and adjust the background lighting of the Joystick Controller(s).

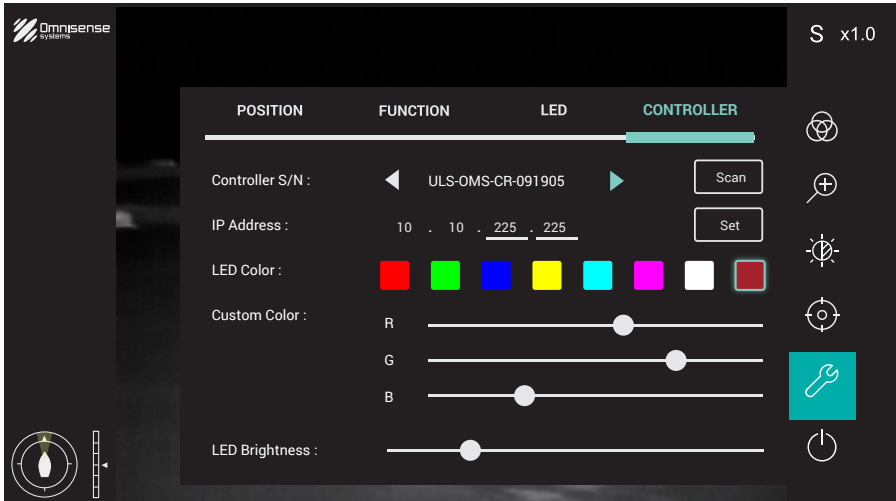

Connecting to the Joystick Controller

To connect your Joystick Controller, select [Scan]. The system will automatically scan for a Joystick Controller connected to the system.

Once the Joystick Controller is found, the serial number will be displayed. Select ⊕ to connect the Joystick Controller, and it will be ready for use.

If the system is unable to locate the Joystick Controller, perform a factory reset to the Joystick Controller by pressing and holding the ↵ and ⏻ buttons simultaneously for 10 sec. Upon completing the reset, the serial number should appear. Select ⊕ again to connect the Joystick Controller.

 Note that to find out the details of other Joystick Controllers, select ◀▶ in the [Controller Serial Number] field to access the various connected Joystick Controller.

See the next page for section image.

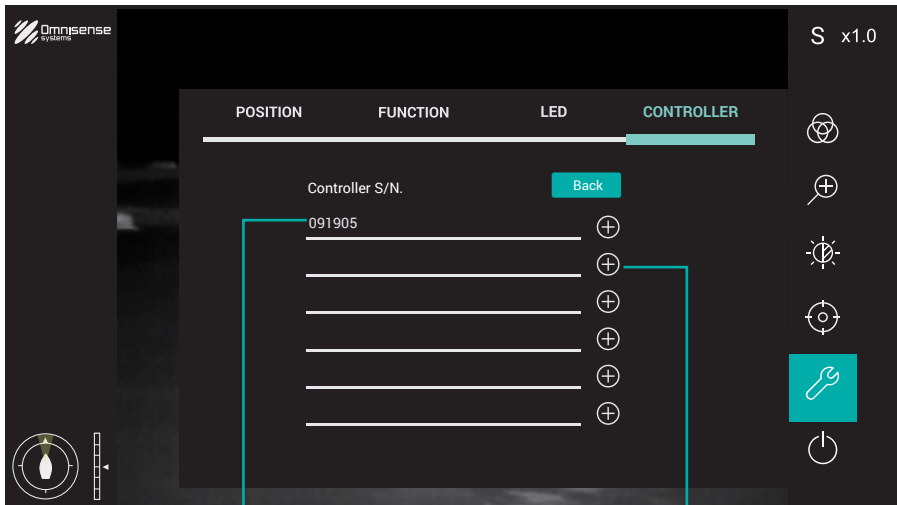

Joystick Controller's serial number

Select this to connect to the Joystick Controller

Connecting additional Joystick Controller(s)

The system is designed to connect to additional Joystick Controller(s). To connect additional Joystick Controller(s) to the camera system network, simply repeat the steps mentioned above.

Changing the Joystick Controller's IP address

If the Joystick Controller's IP address is causing conflict with other equipment in the network, you can change the IP address manually. To change the IP address:

1. Select the IP address field and enter the desired IP address
2. Select [Set] to apply the new IP address.

Adjusting the background lighting of the Joystick Controller

The camera is pre-installed with variable color LED lighting. Select your preferred color from the seven colors preset.

For customization of the lighting's color, select the last color icon and adjust the slider for [Red], [Green], and [Blue] accordingly.

To change the brightness of the LED, simply shift the slider for [LED Brightness].

5.5.8 Junction Box

In this section, you can view the Junction Box serial number and IP address. In addition, you can change the Junction Box's IP address and set the NMEA baud rate.

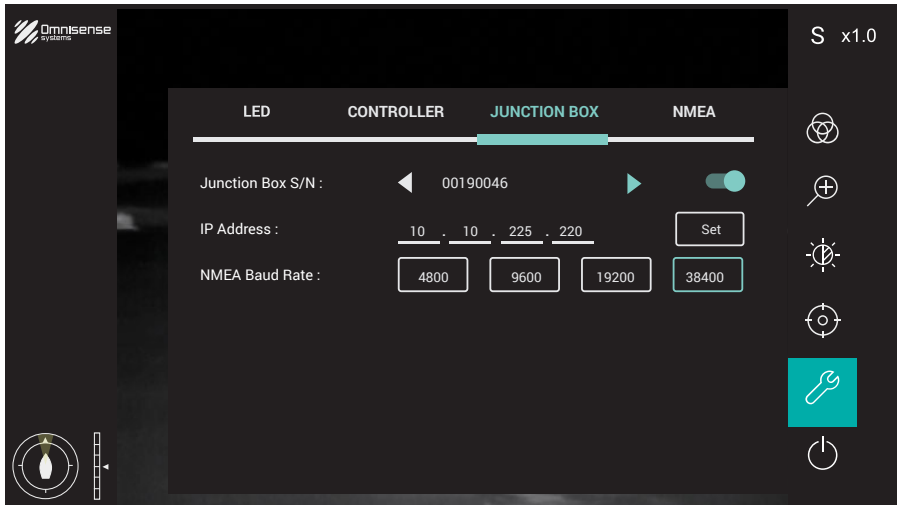

Junction Box S/N

You can view the serial number and the IP address of the Junction Box. To access other Junction Boxes that may have been connected to the system, use the ◀▶ arrow to find the additional ones (if connected).

The enabled/disabled the camera to acquire the radar track coordinates on the selected Junction Box.

Junction Box IP Address

The current IP Address is displayed here. If you need to change the IP address of the Junction Box to prevent IP conflict within the network, enter a new IP address and click [Set].

NMEA Baud Rate

You can set the NMEA baud rate to either 4800, 9600, 19200, or 38400 to complement your existing electronic navigational equipment, such as your radar, GPS and/or AIS.

5.5.9 NMEA

This function allows the camera system to be connected to the NMEA equipment through an Ethernet connection. This allows you to activate the Slew-to-Cue capability of the camera system. To activate the function, slide  to the right.

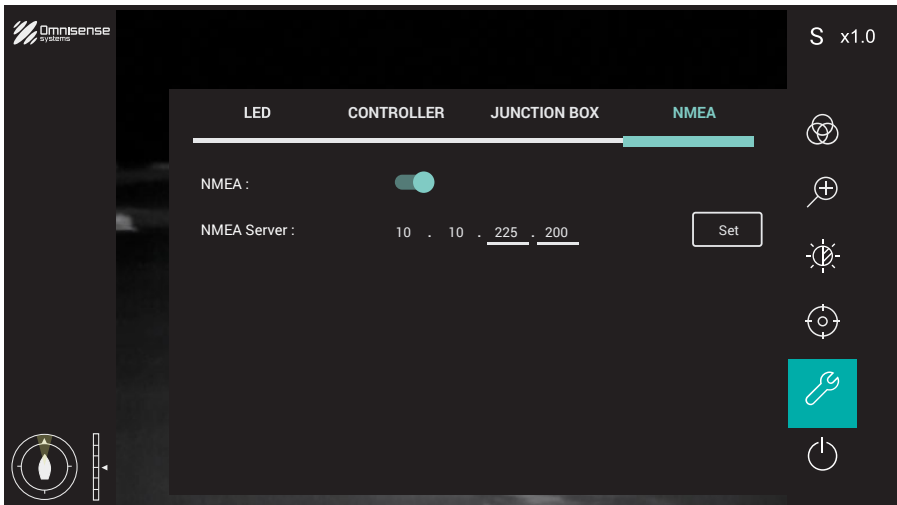

NMEA Server

If the IP address of the NMEA server conflict with other equipment connected to the network, you can change the server's IP address. Enter a new IP address and click [Set].

5.6 Home/Standby

The [Home/Standby] function allows you to wake, park, or return the turret to home position.

- Selecting [Home] will set the turret back to the preset home position.
- Selecting [Standby] will park the turret. The lens will be stored either to face down (ball-up) or face up (ball-down).

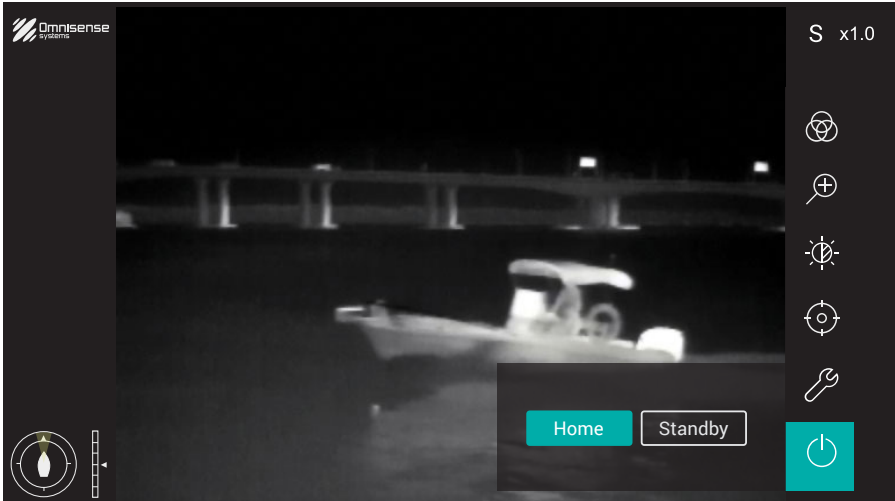

Home

To return turret to home position, select [Home]. To reset or set a new home position (see section 5.5.5).

Standby

To set turret in park position, select [Standby]. The camera lens will be stored faced down (ball-up) or faced up (ball-down). The text on the [Standby] button will change to [Wake Up].

To wake turret from park position, press the [Wake Up] button or long-press the  button on the Joystick Controller.

06 - Day Camera

When you are in the Day Camera mode, you may select  to access the camera's functions and settings. The list of menu icons will appear on the right of the screen. Select a menu icon on the display or use the Joystick Controller to access the respective function listed on the table below.

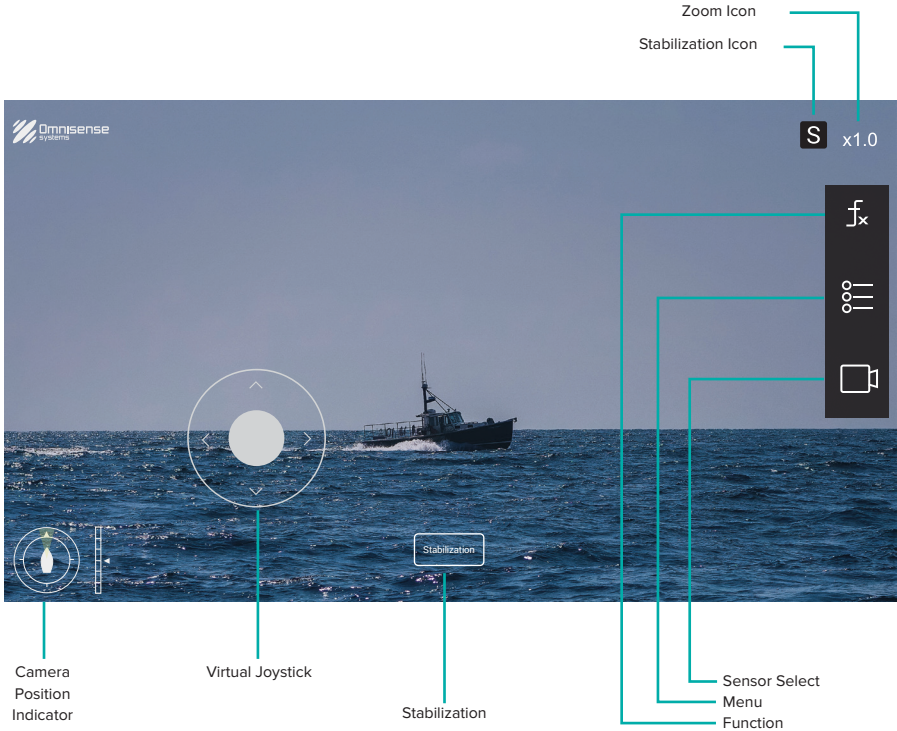







6.1 Menu

Select  to access the functions and settings of the camera. The list of menu icons will appear on the right of the screen. Select a menu icon on the display or Joystick Controller to access the respective function listed on the table below.

 The Color Palette function is not applicable in Day Camera mode.







	Color Palette	This function is not applicable in Day Camera Mode
	Zoom	Zoom level from 1.0 to 48X for Day Camera See section 5.2 for more details
	Brightness & Contrast	Adjust image brightness and contrast See section 5.3 for more details
	Stabilization/Heading Lock/ Radar Slave / Radar Target Track	Radar Slave (Slew-to-Cue) and Radar Target Track Stabilization and Heading Lock See section 5.4 for more details
	Settings	Access to camera's settings See section 5.5 for more details
	Home / Standby	Camera position, Standby and Wake up See section 5.6 for more details

6.2 Zoom

The Day Camera features the ability to zoom into the target object with up to 48X magnification.



- Select  to activate the zoom slider.
- Move the slider left or right to control the amount of magnification.
- For magnification levels ranging from 1x to 12x, each bar shift provides 1x change.
- For magnification levels ranging from 12x to 48x, each bar shift provides a 12x change.

Focus



- Autofocus – Select  to focus the image automatically.
- Manual focus – Select  or  to focus the image manually.
- Select anywhere on the screen or press  on the Joystick Controller to exit menu.





6.3 Brightness & Contrast

- Select  to activate the function.
- Move the Brightness slider left or right to control the amount of brightness.
- Move the Contrast slider left or right to control the amount of image contrast.
- Select anywhere on the screen or press  on the Joystick Controller to exit menu.

Sharpen

- Slide  right to activate the function or slide  left to deactivate.
- Move the Sharpen slider left or right to increase the visual sharpness of the image.
- Select anywhere on the screen or press  on the Joystick Controller to exit menu.

Defog

- Slide  right to activate the function or slide  left to deactivate.
- Move the Defog slider left or right to control the amount of defogging. The Defog function helps improve the image performance in light foggy conditions.
- Select anywhere on the screen or press  on the Joystick Controller to exit menu.

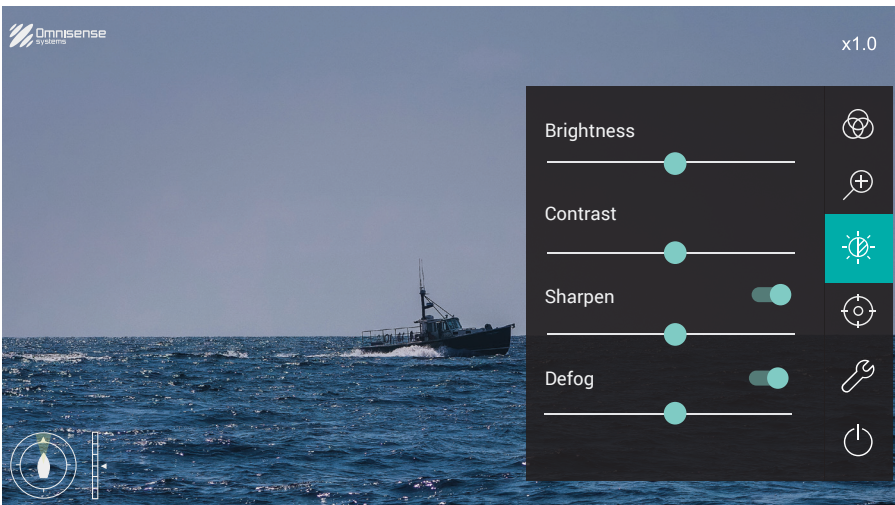

6.4 Radar Track / Stabilization

The functions are similar to the thermal camera mode. Please see section 5.4 for details.

6.5 Settings

Except for the Video's Advanced Settings, the rest of the settings are similar to the thermal camera. Please see section 5.4.1 for details.

6.5.1 Video Advanced Settings

Video's Advanced Settings allows users to adjust the image quality based on the prevailing lighting conditions. Select Advanced Settings to access the following settings:

1. Dynamic Contrast Improvement
2. Dynamic Range Compression
3. White Balance
4. Hue / Saturation

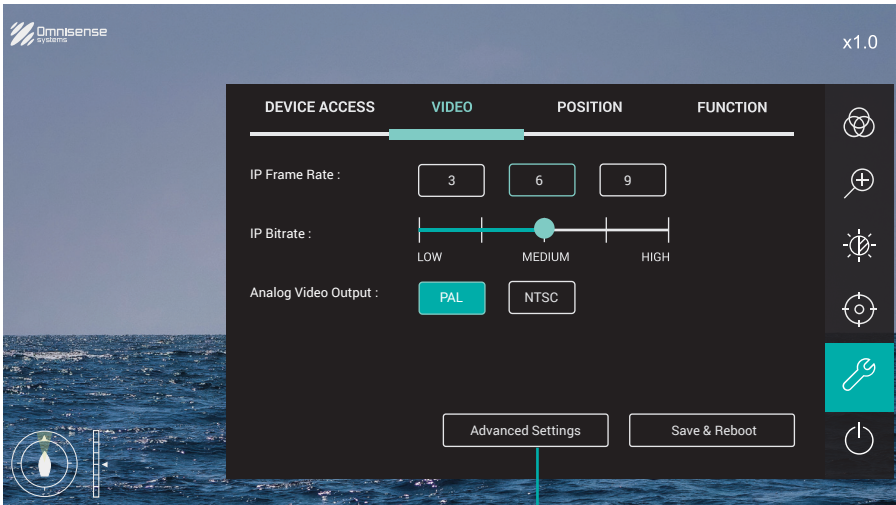

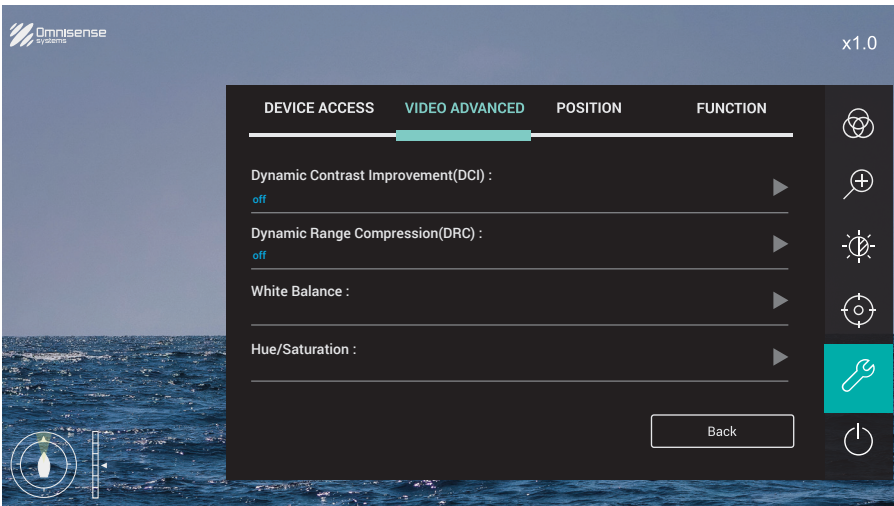

Advanced Settings



Dynamic Contrast Improvement

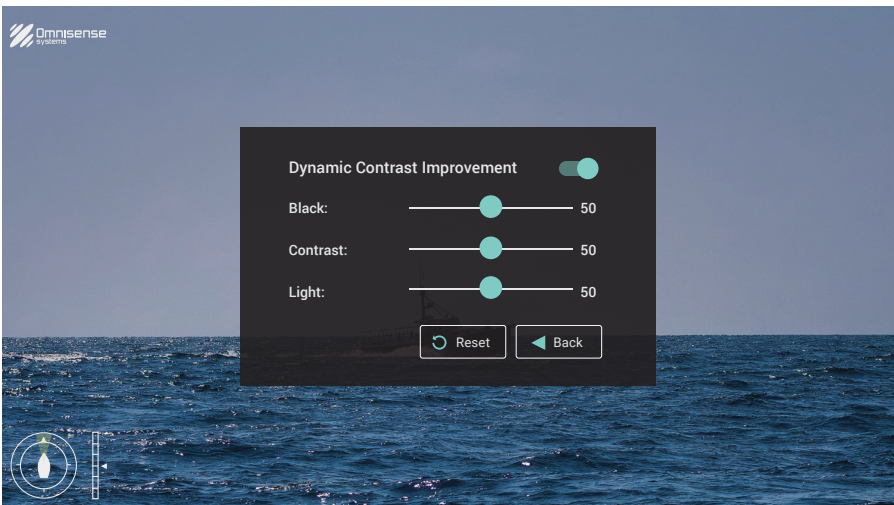

Dynamic Contrast Improvement allows automatic or manual adjustments of contrast settings according to the environment in order to provide better image contrast.

- Slide  right to activate the function or slide  left to deactivate.
- Move the Black, Contrast, and Light slider left or right to adjust the image for better contrast.



Dynamic Range Compression

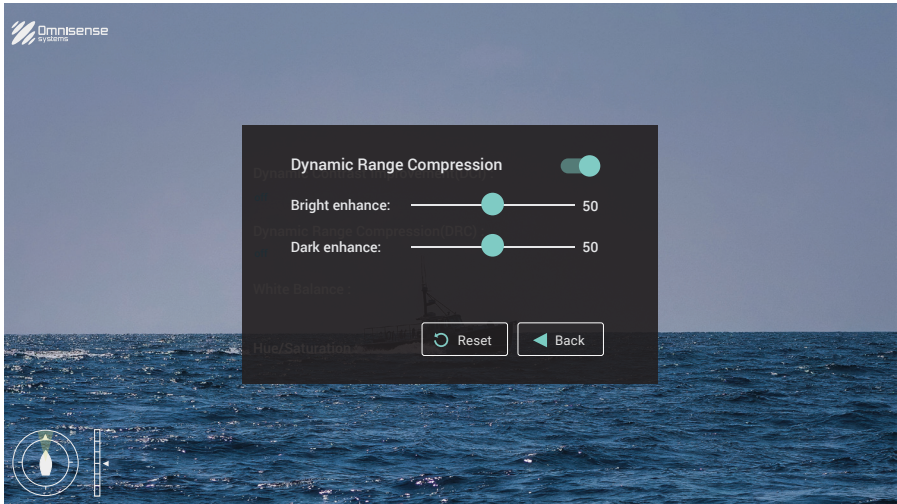

Dynamic Range Compression improves image quality in high contrast lighting conditions. It allows the camera to balance the contrasting light for a clearer image.

- Slide  right to activate the function or slide  left to deactivate.
- Move the Bright enhance or Dark enhance slider left or right to adjust the image for better contrast.



White Balance

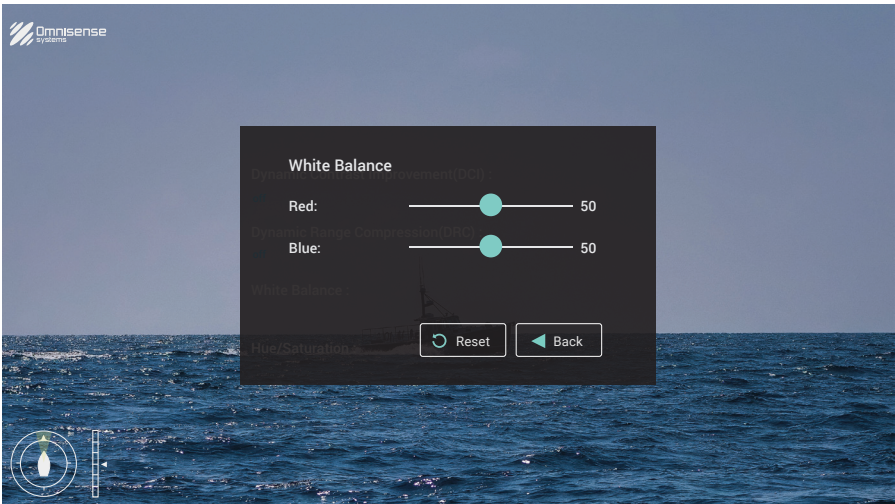

White balance adjusts the camera's color sensitivity to match the prevailing color of light.

- Slide  right to activate the function or slide  left to deactivate.
- Move the Red or Blue slider left or right to adjust the image.



Hue / Saturation

Hue/Saturation filter allows adjustment of hue and saturation of the image.

- Slide  right to activate the function or slide  left to deactivate.
- Move the Hue or Saturation slider to the left or right to adjust the image.

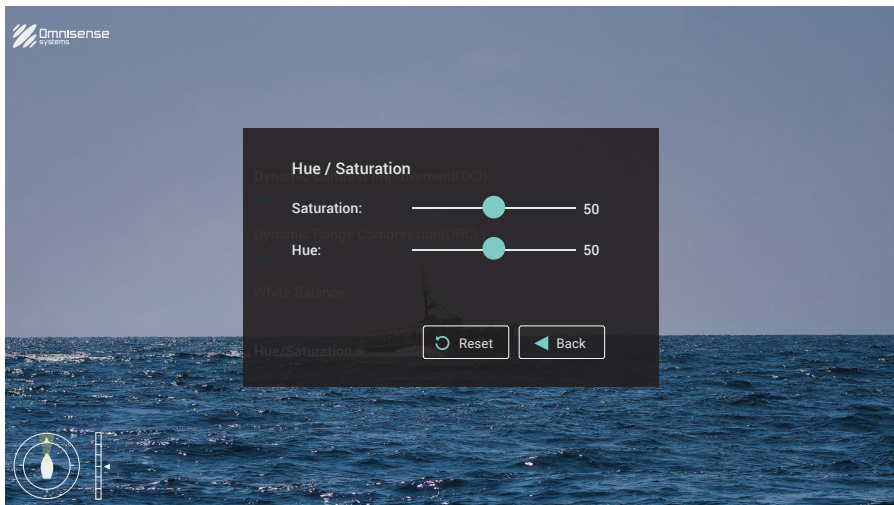

07 - Joystick Controller





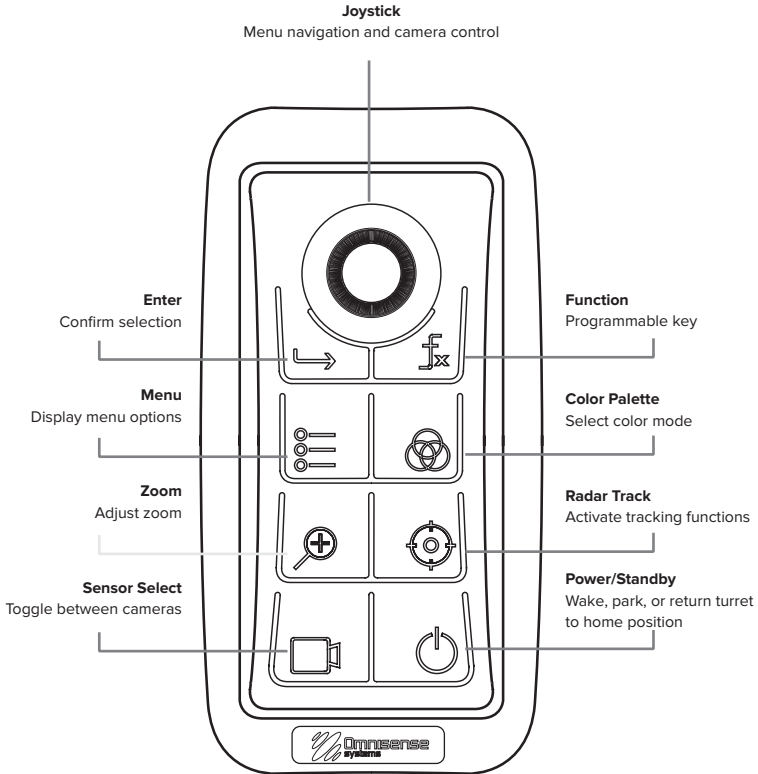



The 8 buttons provide display controls on the Joystick Controller and the Virtual Controller on the web browser.

Press the ☰ button once to access the menu items. Use the joystick to select and cycle through the options available.



Joystick Controller icon description

Below is the description of each icon for further understanding.

	Joystick	Move the joystick to pan and tilt the camera Navigate through the menu items Adjust Zoom/Focus, Brightness & Contrast
	Enter	Press to confirm a selection
	Menu	Press to display the options available See chapter 5 for more details
	Zoom/Focus	From 1.0X to 4.0X (Thermal Image only) Use the joystick to control the amount of zoom See section 5.2 for more details
	Sensor Select	Toggle between thermal and day cameras
	Home/Standby	See section 5.6 for more details
	Radar Track	Radar Tracking or Slew-to-Cue See section 5.4 for more details
	Color Palette	Select from 6 different color palettes See section 5.1 for more details
	Function	Programmable shortcut key See section 5.5.6 for more details

08 - Maintenance

8.1 Caring for the camera

Cleaning:

After each trip out at sea, gently flush the Turret with fresh water to prevent the accumulation of minerals from saltwater and sea spray.

The sensor lens has a protective coating that may be easily damaged. Do not use paper or any dry fabric to wipe the lens. Use a soft cloth instead and a small amount of mild soap if you need to remove any stains on the lens. Do not apply pressure, as this could result in damage.

Important:

Disassembly of the cover and/or camera can cause permanent damage and will void the warranty.

Ensuring the integrity of the installation:

Perform routine inspection of the camera, controller, and mounting surface to ensure that it is securely installed. When the system is powered off, grasp the camera and controller firmly at the base to confirm that it is secured soundly.

Do not leave the lens pointed at the sun:

Do not leave or park the lens pointed at the sun or other strong light sources for an extended period. Intense light may cause the image sensor to deteriorate or produce a white blur effect in images.

8.2 Storage

If the camera is not going to be used for an extended period, uninstall and store it covered in a cool, dry, well-ventilated area.

Do not store your camera with naphtha or camphor mothballs or in locations that are:



- poorly ventilated or subject to humidity over 60%
- next to equipment that produces strong electromagnetic fields, such as televisions or radios
- exposed to temperatures above 85°C or below -40°C



8.3 Service and maintenance

This product contains no user-serviceable components. With the exception of regular cleaning, please refer all maintenance and repair to Omnisense Systems. Unauthorized repair will void the manufacturer's warranty.

09 - Troubleshooting

If the camera fails to function as expected, check the list of common problems below before consulting your retailer or Omnisense Systems representative.

Problem/Error Indications	Possible causes	Possible solution
Junction Box - Power LED not lighted	No power to the Junction Box	Check that the power is switched on. Check that the power cable at the Junction Box is secured properly.
Junction Box -POE A LED not lit	Joystick Controller cable loose	Check that the Joystick Controller cable is connected fully at the Joystick Controller and [Controller] port in the Junction Box.
Junction Box -POE B LED not lit		If the Joystick Controller is connected to this switch, refer to solution for Junction Box - POE A LED not lit. Note: This is normal if the MFD is connected to this POE switch.
Junction Box -POE C LED not lit	Camera Harness loose	Check that the Camera Harness is connected correctly at the turret and the other end is fully connected at the [Camera] port in the Junction Box
Junction Box -Alarm LED blinked	One of the equipment connected to the Junction Box is drawing excessive power (more than 28W)	The system will cut off all power to the equipment connected to it and automatically reset. Note: Only products from the camera system are certified to be connected and draw power through the Junction Box.
No images on the display	Loose cable connections between junction box and MFD/ HDMI display incorrect IP input if connecting via web browser	Check that the cables between the Junction Box and your MFD/ HDMI display are properly connected and that your MFD/Monitor has been powered on. Re-input the IP address provided into your computer.
Image too dark	Insufficient contrast or brightness	To adjust the brightness of the image, select  to adjust the brightness and/or contrast or select  and change to another color palette.
Image flickering	Loose connections	Check that the cables are connected properly and secured into the respective ports.
Jerky images	IP address settings	If you are connected to a laptop, check if the IP address conflicts with your existing IP settings.
GUI unresponsive		see Jerky Images.
No response from the Joystick Controller	Improper connection	Check that the cables are correctly connected and secured to the respective ports. Check if the Joystick Controller's IP exists inside the settings page. Re-setup the system if necessary.

Unable to use the Slew-to-Cue Function	Improper connection	Check to confirm MFD capability with this function and that the RSD sentence is selected in the MFD menu. Check the NMEA 0183 connections, make sure that the cables have been secured into place and that the polarity for both TX and RX is connected correctly.
Cannot pan/tilt	Dirt build-up	Check the space between the turret and the mounting base for any build-up of deposits. Then, gently flush the turret and the mounting base with fresh water to dislodge the accumulation of minerals from saltwater and sea spray.
If the camera stops responding	Possible strong external static charge conflicting IP with other equipment onboard	Switch off the power to the camera. Once the camera is off, wait a few seconds and then turn the camera back on. If the problem persists, conduct Factory Reset. Plug in the power supply to the Junction Box for 15 sec, then remove the power supply from the Junction Box for 5 secs. Perform this action for a minimum of 5 times. On the 5th time, keep the system powered up, and you should be able to operate the camera system. Note: The camera turret IP will reset to the factory default IP. You may change the IP from the settings page.
Joystick Controller not responding to other troubleshooting actions	Conflicting IP with other equipment onboard	Press and hold the  and  buttons simultaneously for 10 sec. The Joystick Controller's IP will be reset to the default. To re-connect the Joystick Controller to the system, you will need to set the camera's IP back to the default IP. The equipment should be connected thereafter.
Junction Box	Conflicting IP with other equipment onboard	Press the button - SW10 RST (just beside the NMEA junction connector) for 10 sec. The Junction Box's IP will reset to the default IP. To re-connect the Junction Box to the system, you will need to set the camera's IP back to the default IP. The equipment should be connected thereafter.
Forget login password		Conduct Factory Reset (See "If the camera stops responding")

10 - Specifications

<p>General</p> <p>Sensor Type</p> <p>Field of View</p> <p>Zoom</p>	<p>Thermal Camera</p> <p>640 X 480</p> <p>17um uncooled microbolometer</p> <p>24° X 18° (Mini) 18° X 12° (Mini+)</p> <p>Continuous electronic zoom to 4X</p>	<p>Color Camera</p> <p>8.5m</p> <p>1/2.5" Exmor R STARVIS CMOS</p> <p>35.4° x 20° (Wide) 9° x 5.2° (Tele)</p> <p>HyperZoom 8X / E-zoom 6X</p>
<p>System Specifications</p> <p>Pan / Tilt Coverage</p> <p>Gyro Stabilization</p> <p>Video Output</p> <p>Video Frame Rate</p> <p>Power Consumption</p> <p>Power Requirements</p>	<p>Pan: Continuous 360° Tilt: 100°, -90°</p> <p>Yes</p> <p>NSTC or PAL, HDMI, IP video</p> <p>9fps</p> <p>25W max</p> <p>PoE</p>	
<p>Environmental</p> <p>Operating Temperature Range</p> <p>Storage Temperature Range</p> <p>Encapsulation</p> <p>EMI / Salt Mist / Vibration</p> <p>Wind</p> <p>Lightening Protection</p>	<p>-13°F to 131°F</p> <p>-22°F to 158°F</p> <p>IP 66</p> <p>IEC60495</p> <p>115mph / 100kn</p> <p>Standard</p>	
<p>Range Performance</p> <p>Detect Man (5.9 ft X 1.5 ft)</p> <p>Small Vessel (13 ft X 4.9 ft)</p>	<p>Mini</p> <p>Up to 0.8mi</p> <p>Up to 1.8mi</p>	<p>Mini+</p> <p>Up to 1.1mi</p> <p>Up to 2.5mi</p>
<p>Dimensions</p> <p>Size</p> <p>Weight</p>	<p>7.4" X 15.5"</p> <p>≤ 15.4lb</p>	

Note:

1. Due to our policy of continual improvement, specifications may change without prior notice.
2. System must not be used in replacement of human observation.



Omnisense Systems USA Inc

1881 West State Road 84, Bldg. 1 Unit 102
Fort Lauderdale, Florida, 33315, United States

T: +1 (954) 316-6230

E: enquiries@omnisense-systems.com



omnisense-systems.com